Table of Contents

E65 Instrument Cluster

Subject	Page
E65 Instrument Cluster	5
Hardware	6
Integrated Functions of the Instrument Cluster	7
Components	8
Display Areas of the Instrument Cluster	8
LC Display	8
Display Area 1, Inside the Speedometer	9
Speed Limit Warning Field	9
Cruise Control	9
Test Functions	10
CBS Reset	10
Display Area 2, Inside the Tachometer	11
Variable Engine Speed Advance Warning Field	11
Navigation Display	11
Display Area 3, Below the Speedometer	12
Display Area 4, Below the Tachometer	12
Display Area 5, Variable Display and Warning Field	13
CC Warning Symbols	13
Outside Temperature	13
Time	13
Display Area 6, Gear Display	14
Pointer Instruments	14
Speedometer	14
Tachometer	15
Indicator and Warning Lamps	15
Illumination and Dimming	17
Turn Signal Acoustic Feedback	18
Trip Odometer Reset Button	18
Input and Output Signals	19
I-P-O	20
K-CAN System Telegrams	21
Speed	21
Gearbox Data	21

Subject	Page
Engine Speed (RPM)	22
Outside Temperature	22
CBS Messages	22
Bus Status	22
Dimming	22
Driver Display, Speed Range	22
Parking Brake (EMF)	22
Vehicle Identification Number	23
Vehicle Type	23
Mileage Reading/Range	23
Terminal Status	23
Lamp Status	24
LCD Brightness	24
Engine Data	24
Network Management K-CAN	24
RDA Request/Data Storage	24
Cruise Control	24
Power Management Battery Voltage	25
Relative Time	25
Status Damper Program	25
Status DSC	25
Alive Counter EMF	25
Time/Date	26
Status Radio-Control Key	26
Status Instrument Cluster	26
Central Locking System and Trunk Lid Status	27
MOST Bus	27
Check Control	28
Display Locations	29
Display Characteristics	29
Operation	30
On-Board Computer (BC)	31
New Features	31
On-Board Computer	33
Travel Computer	36
Limit	37
Stopwatch	38
Settings	38
Clock	38
Memo Signal	38

Subject	Page
Workshop Hints	39
Redundant Data Storage	39
Installation of a New Instrument Cluster	40
Installation of a New or Used Instrument Cluster for Test Purposes ..	40
Simultaneous Replacement of CAS and Instrument Cluster (new) ..	41
Instrument Cluster Test Functions	42
Starting a Selected Test Function:	43
Test function 01: Identification	43
Test Function 02: System Test	44
Test Function 03: Not Used	44
Test function 04: Consumption	44
Test Function 05: Range Consumption, Current Range Value ...	45
Test Function 06: Fuel Tank and Displayed Value	45
Tank phase 1:	45
Tank phase 2:	45
Tank phase 3:	45
Test Function 07: Coolant Temperature, Outside Temperature,	
Dimming Photocell, Engine Speed	46
Test Function 08: Current Vehicle Speed	46
Test Function 09: Operating Voltage	46
Test Function 10: Read Out Country Code	46
Test Function 11: Read Out Units	47
Test Function 12: Displays for Arrival	47
Test Function 13: Trigger Acoustic Signals	47
Test Function 14: Self-Diagnosis	47
Test Function 15: Display of I/O Port Statuses	48
Test Function 16: Display Test Bitmap	48
Test Function 17: Analog-Digital Converter ADC	48
Test Function 18: PWM Values	49
Test Function 19: Lock and Release Test Functions	50
Test Function 20: Correction Factor for Average Consumption ...	51
Test Function 21: Software Reset/RAM Reload	52
Resetting Condition Based Service (CBS) Display	53
 Overview of Check Control Messages	 58

E65 Instrument Cluster

Model: E65/E66

Production: All

OBJECTIVES

After completion of this module you will be able to:

- Understand the role of the instrument cluster as part of the iDrive concept
- Recognize and understand various information items supplied to the driver
- Explain how to access the various display items from the instrument cluster

E65 Instrument Cluster

For consistent integration into the new operating and display concept, “iDrive”, a completely new instrument cluster has been developed for the E65.

The following goals were taken into account during development:

- The instrument cluster is an integral part of the iDrive/Driving Area.
- All of the necessary information for driving the vehicle must be on display in the direct field of vision of the driver in a simple and easily understandable form.
- Display technology with outstanding ergonomics due to graphic displays.
- New type of Check Control system with clear, understandable texts and graphic symbols.

With these goals realized, the instrument cluster has become a multifunctional display unit that links the benefits of various display technologies into a single unit.

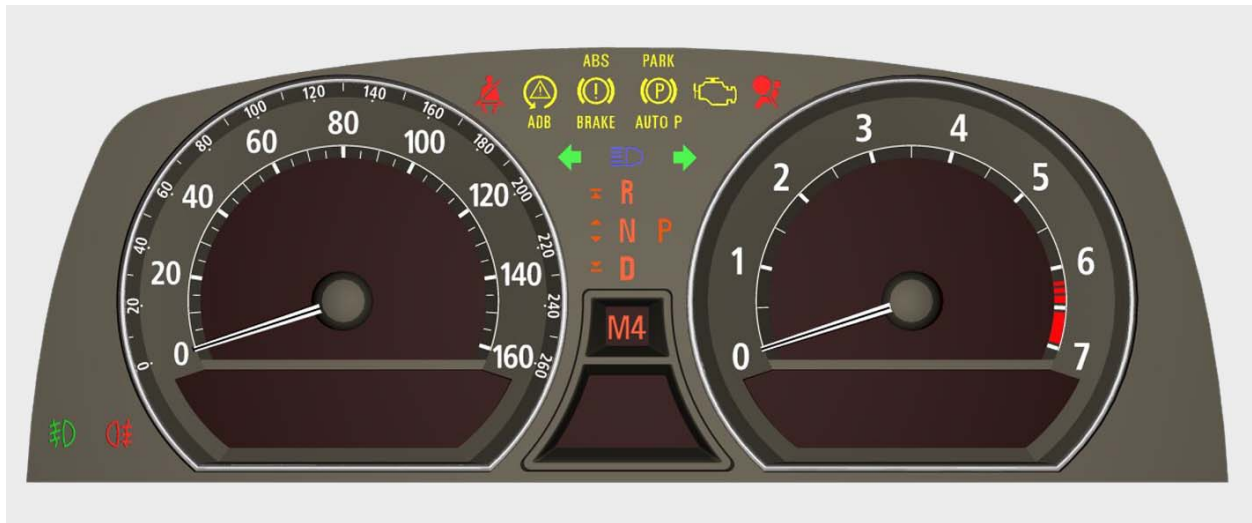

Hardware

The instrument cluster is designed as a complete integrated component and secured to the dashboard with three screws. It is connected to the vehicle communication system via the data buses: K-CAN System and MOST.

The display of road speed and engine speed is by means of pointer instruments. The pointers are moved by stepper motors. The pointers move over an LC display.

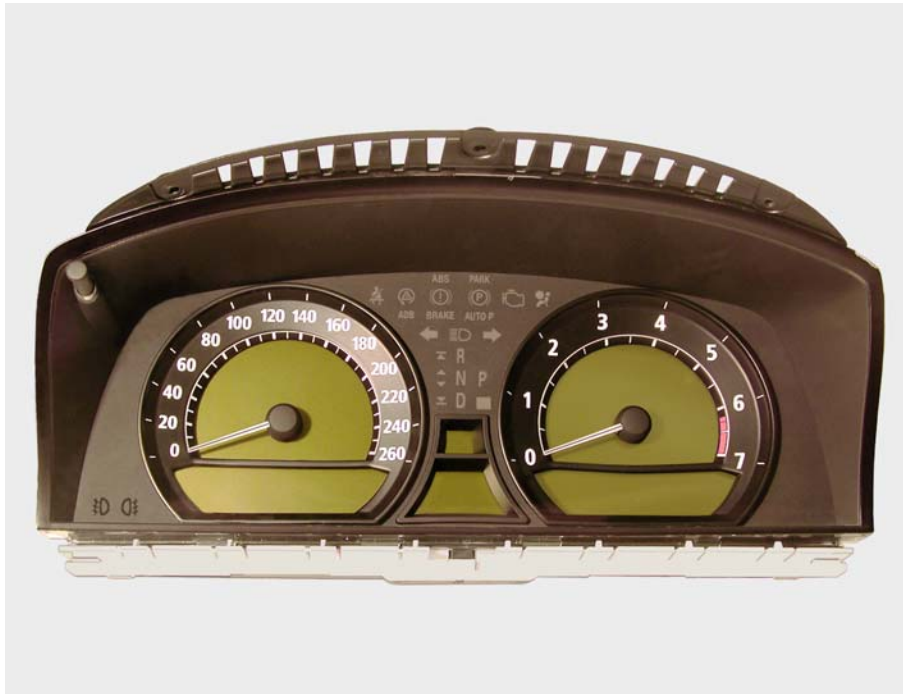

The fuel and temperature gauges have been deleted from the instrument cluster and are now an On-Board Computer and Check Control display respectively.

The scale and labeling of the tachometer and speedometer are printed on a frame and placed over the LC display. The legally required displays are in the form of fixed-position, standardized indicator and warning lights. The indicator and warning lights are arranged between and next to the pointer instruments.

The indicator and warning lights as well as the back light of the LC display use single color and multi-color LEDs. The light emitting diodes are designed to last the service life of the vehicle and cannot be replaced.

All other displays and messages (e.g. those of the on-board computer) are represented on the LC display, which is visually divided into six display fields by the frames of the pointer instruments.

The control unit is integrated in the instrument cluster. The control unit consists of a high-performance 32-bit computer for the display and lighting as well as the BC and CC functions. Another 8-bit computer is responsible for activation of the pointer instruments and the fixed-position indicator and warning lights.

A memory of 4MB for the U.S. instrument clusters is used to store the language and units variants. Language and units can be changed using the Control Display.

The following languages and units are stored in the language memory (4 MB) of the instrument cluster:

- German
- English (US)
- Italian
- English (UK)
- French
- Spanish

Depending on the country code stored in the Car Access System (CAS), a language package consisting of three of the languages listed above is programmed in the CD. A language can be selected from these three languages in the CD. For U.S. versions the selectable languages are English (U.S.), French and Spanish.

The setting of units and languages can be saved as a key memory function. This means that the units and languages are displayed automatically depending on the key used (user).

Integrated Functions of the Instrument Cluster

- Pointer instruments for road speed and RPM.
- Indicator and warning lamps.
- On-board computer (BC).
- Check Control CC.
- Test functions.
- Time signal source (time master).
- Dim signal source (dimmer master).
- Outside temperature signal source (outside temperature master).
- Turn signal indicator acoustic output.
- Codeable memory for languages and units.
- Fault code memory.

Components

Display Areas of the Instrument Cluster

The instrument cluster uses three main display devices:

- LC display
- Pointer instruments
- Warning indicator lamps (LEDs)

LC Display

The LCD unit is the digital display area. A frame placed over the LCD unit visually separates it into six display areas for the indicator and warning lamps. A special feature here is that holes had to be drilled through the LC display for the connection of each pointer instrument (speedometer and tachometer).

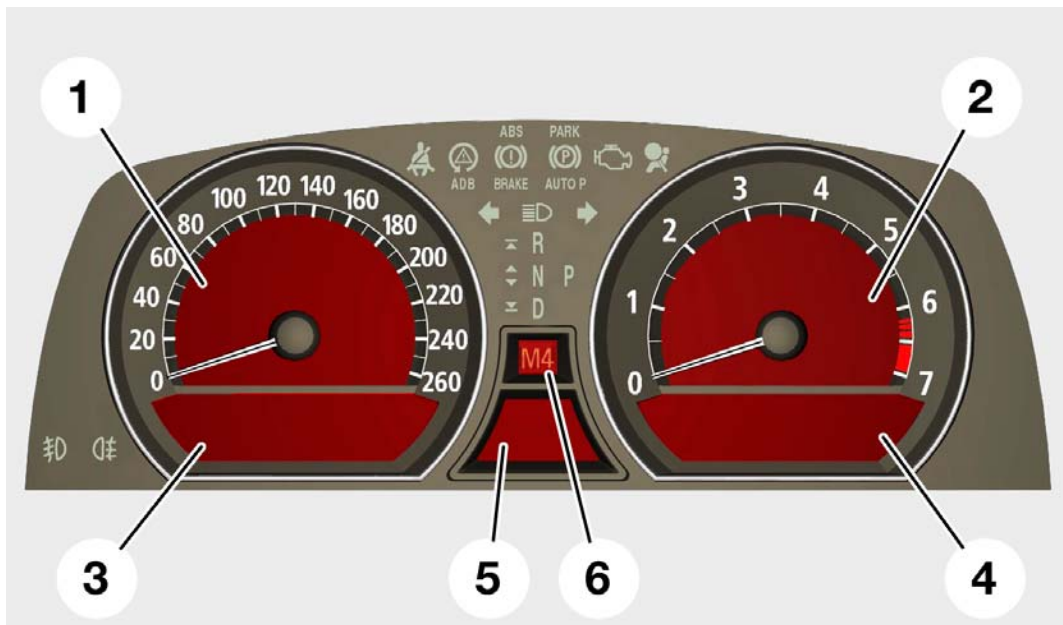

Index	Explanation	Index	Explanation
1	Display area 1 (Speedo)	4	Display area 4
2	Display area 2 (Tach)	5	Display area 5
3	Display area 3	6	Display area 6

In order to ensure that the LC display can also be read easily at low temperatures, the display is heated. The heating consists of heating wires on a sheet behind the display. When the driver's door is opened, the switch-on signal is sent by the CAS via the K-CAN System bus to the instrument cluster.

The display heating is activated at temperatures below 10°C (50°F).

Display Area 1, Inside the Speedometer

In this display area, the following content can be displayed in the form of text and graphics:

- Speed limit warning field
- Cruise control
- Test functions
- Condition Based Service (CBS) reset

Speed Limit Warning Field

In order to prevent the speed limit from being exceeded, the driver can use the On-Board Computer to set a desired speed limit.

When the speed limit is set, an illuminated bar segment beginning at the set limit appears in this display area.

The circle segment starts at the desired limit and extends to the scale limit. If the set limit is exceeded, an acoustic signal sounds.



Cruise Control

The cruise control offers the possibility to save speed points which can be activated when required.

This enables easy selection of speeds that are frequently required, for example 55, 65, 70 mph at the push of a button without having to go to precisely to that speed and then set it.

Up to 6 speed points (dots) are possible.

When the cruise control is active, a bright arrow marks the speed currently set for control.

If the cruise control has been deactivated (e.g. after braking), the speed points to which the control was last set (while driving) is marked by a dim arrow.



Test Functions

The trip distance reset button can be used to select a total of 21 test functions in display area 1. The content of the test function appears in display area 2. The test functions are described in detail in Workshop Hints.

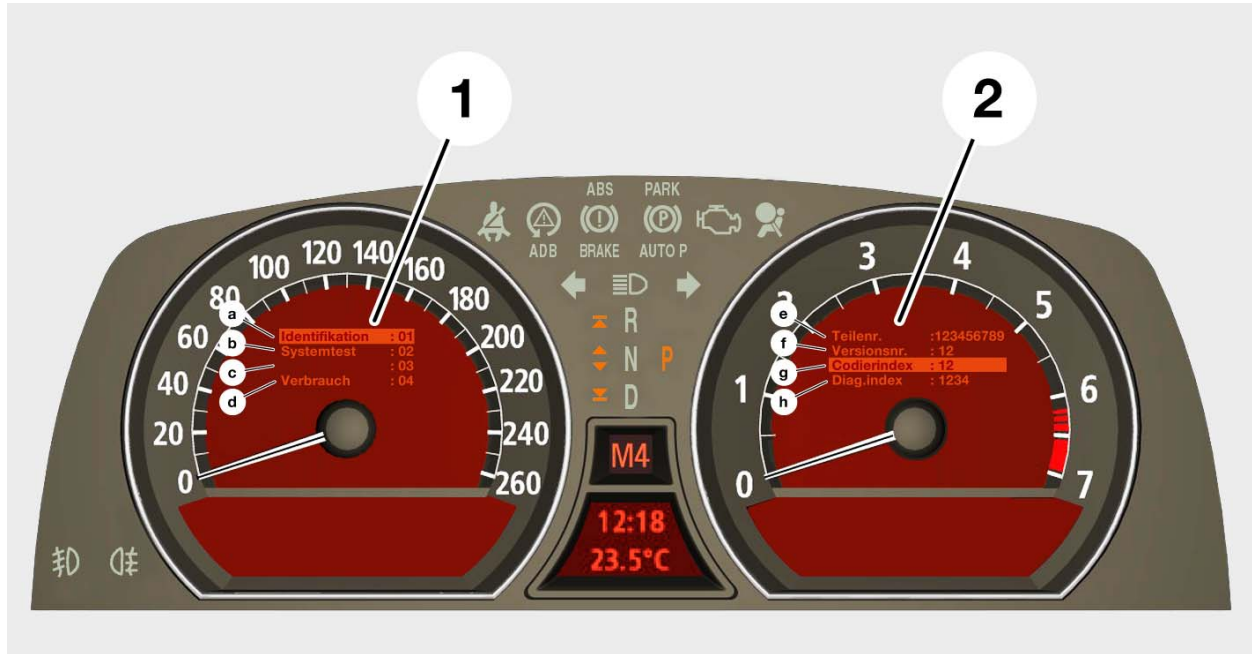

CBS Reset

The trip distance reset button can be used to select the CBS reset functions in display area 1. The content of the functions appears in display area 2. The CBS reset functions are described in detail in Workshop Hints.

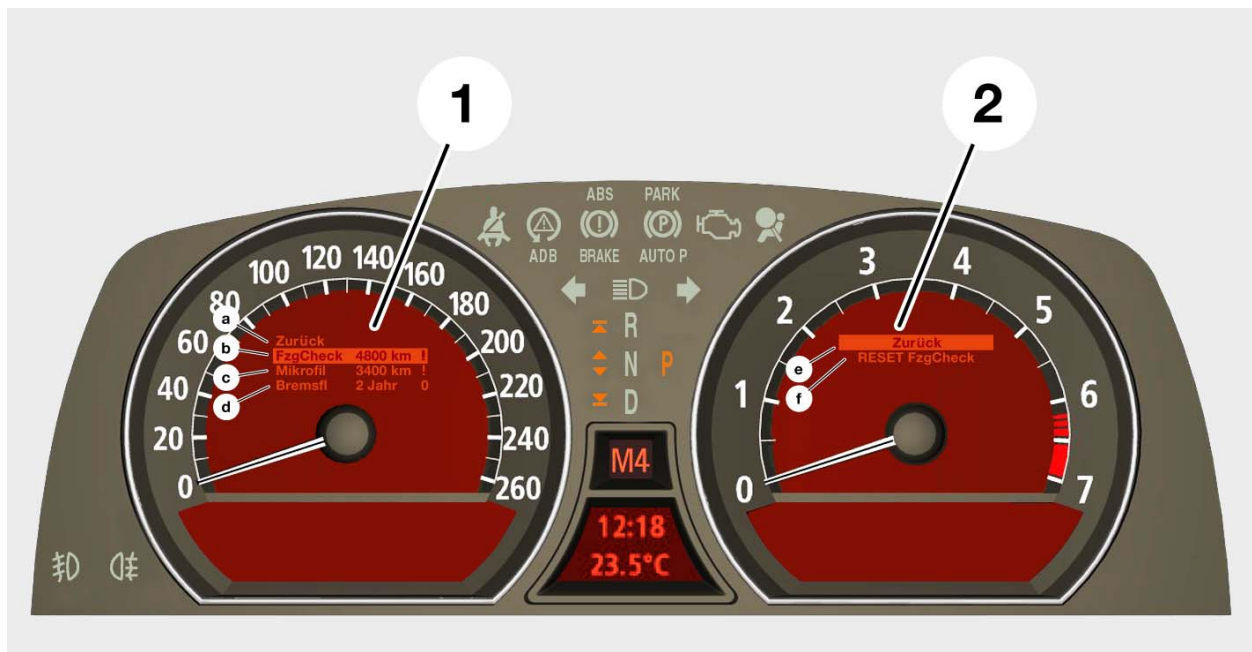

Display Area 2, Inside the Tachometer

In this display area, the following content can be displayed in the form of text and graphics:

- Variable engine speed advance warning field
- Navigation display
- Diagnosis test functions

Variable Engine Speed Advance Warning Field

The scale of the tachometer contains a fixed (painted) engine speed advance warning field (dashed red) with subsequent engine speed warning field (continuous red).

In addition, similar to the M5, the display area contains a variable engine speed advance warning field below the engine speed scale.

Here, depending on the engine temperature, a maximum engine speed recommendation is displayed to the driver. When the engine is at operating temperature this display disappears.



Navigation Display

Guidance information (round arrow), the next junction and the distance to the next junction are displayed. Up to a point shortly before the turn-off, the distance to it is showed numerically. It is then displayed in a bar chart.

The bar decreases in size continuously until the turn-off is reached. Whether the distance to the next turn-off is displayed numerically or as a bar chart is determined by the navigation system. The data is transferred from the navigation system by MOST bus telegram to the instrument cluster.



Display Area 3, Below the Speedometer

In this display area, the following content can be displayed in the form of text and graphics:

- Service requirement display (SBA)
- On-board computer (BC) (fuel gauge, range)

If there are no messages from the SBA, the fuel gauge or (depending on setting) range is displayed here.

Pressing the BC key on the turn indicator switch toggles between the BC displays.

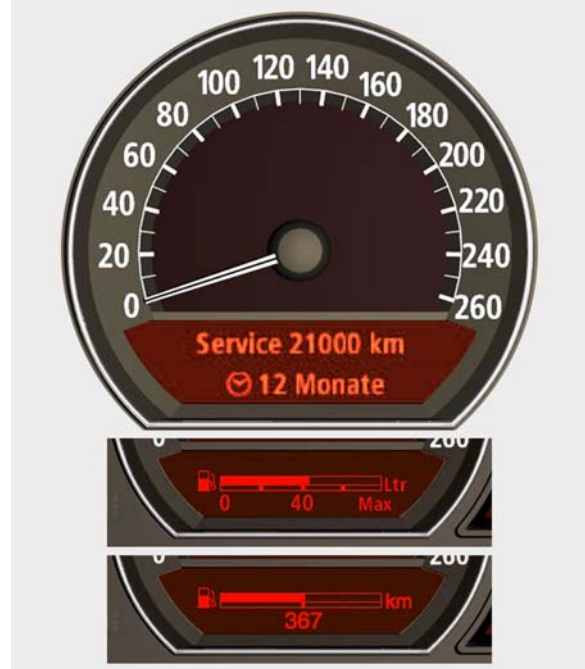

Display Area 4, Below the Tachometer

Both BC and CC text messages are shown in this display area. The BC text messages are overwritten by the CC text messages. Most CC text messages are supplemented by a symbol matching the message being displayed in the variable display and warning field (display area 5).

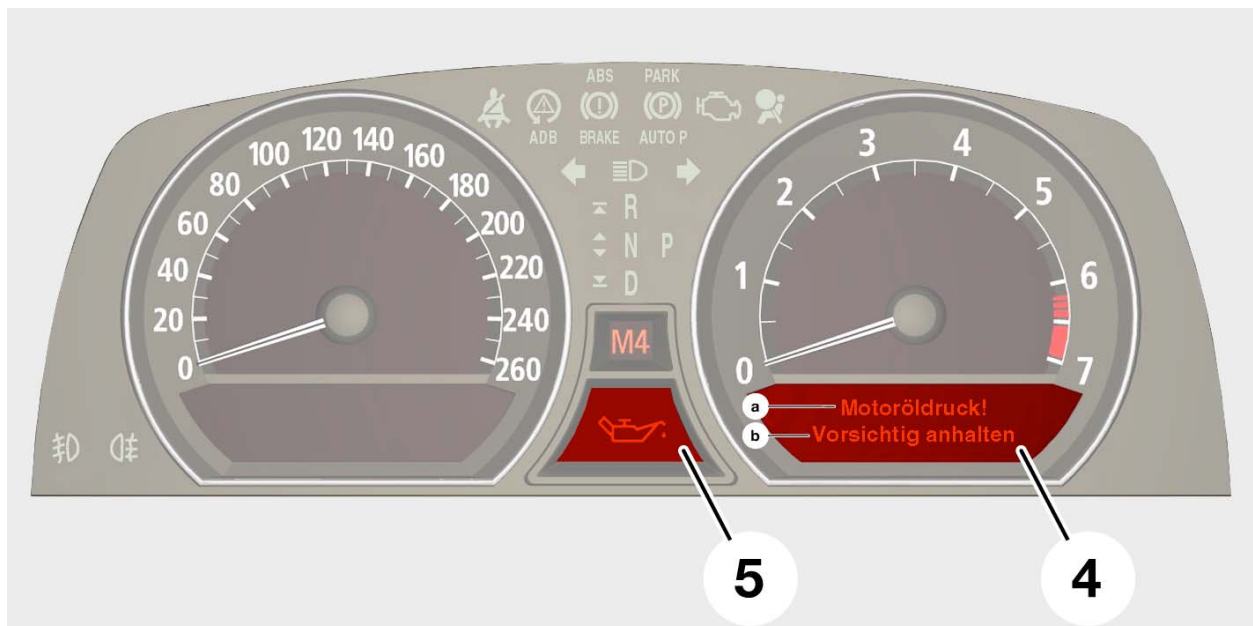

Display Area 5, Variable Display and Warning Field

This area serves as a variable display and warning field. In this display area, the following content can be displayed in the form of text or graphics:

- CC warning symbols
- Outside temperature
- Time

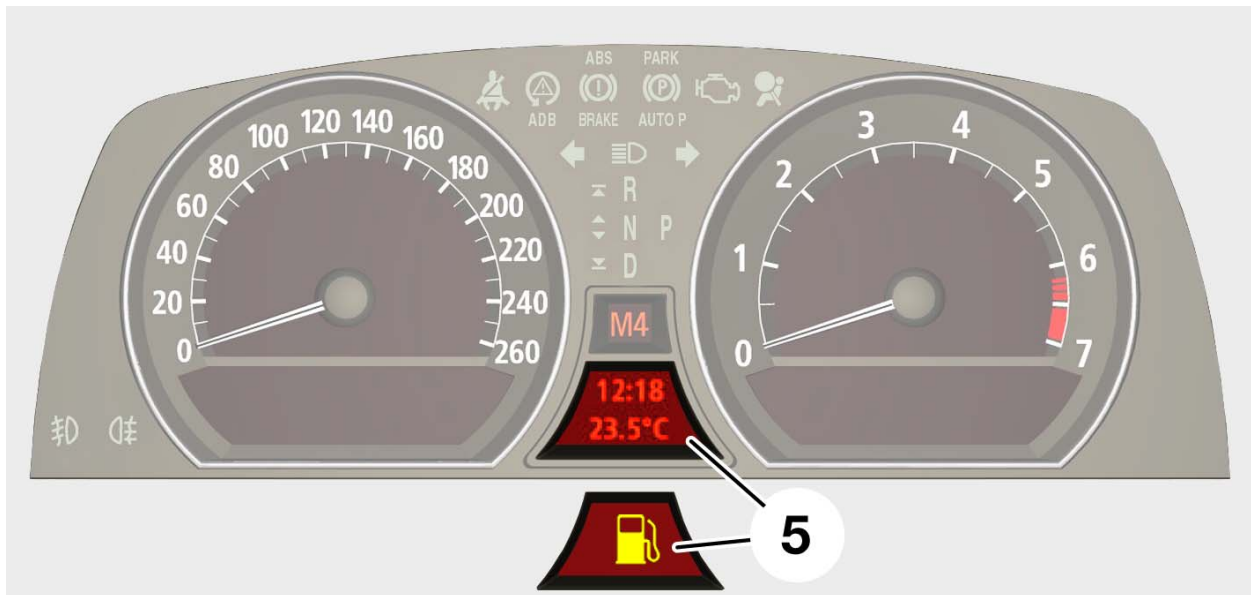

CC Warning Symbols

Each CC text message (in display area 4) is assigned a symbol that appears in the variable display and warning field. The warning symbols are displayed in red or yellow. If there are no CC messages, outside temperature and time are displayed here permanently.

Outside Temperature

If the temperature falls below +3 °C (37°F), a CC message with acoustic warning is issued. The outside temperature is calculated and displayed by the instrument cluster taking the factors of engine-coolant temperature and vehicle speed into account.

Time

There is an integrated quartz crystal clock in the instrument cluster. The time appears in display area 5 of the instrument cluster and can be set manually by the driver using the controller in the CD. The display of time and outside temperature takes place as of KL R ON.

Display Area 6, Gear Display

When using the “Low” mode, the gear engaged by the gearbox is displayed in this display area (L1 to L6). Steptronic will be available in the U.S. later in production, with the introduction of the 745i sport and 760Li.

In the Steptronic mode, the gear engaged by the gearbox is displayed in this display area (M1 to M6). In driving program position D and activated S program, an S is displayed here.

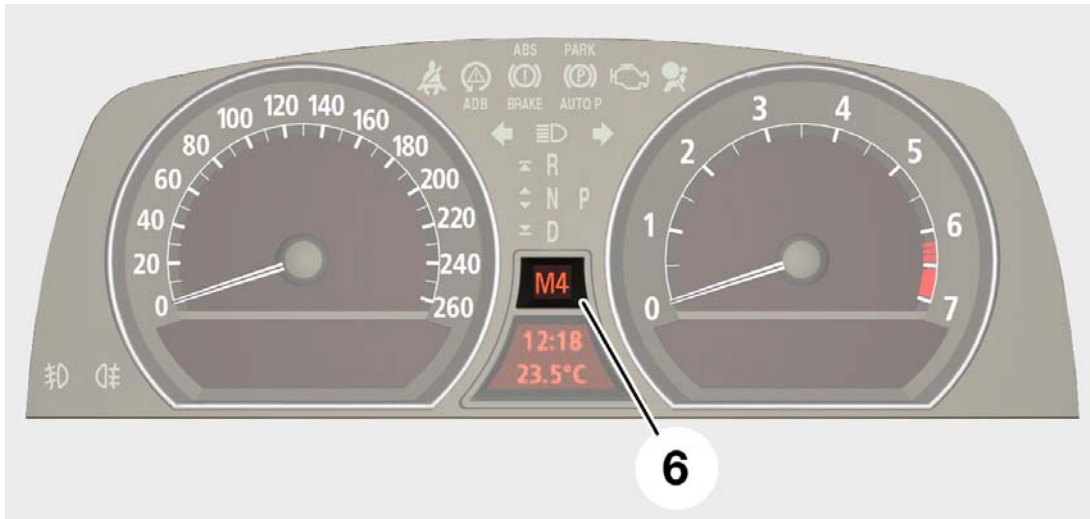

Pointer Instruments

Speedometer

The speedometer scale and the scale lettering are shown on the fixed-position dial. The pointer is moved by a stepper motor. The speed signal goes from the DSC control unit via the PT-CAN to the ZGM and from there via the K-CAN System to the instrument cluster.

The signal from the left-hand rear wheel sensor, as processed by the DSC control unit, is used here.



Tachometer

The tachometer scale and the scale lettering are shown on the fixed-position dial. The dial of the tachometer contains a fixed engine speed advance warning field (dashed red) with subsequent engine speed warning field (continuous red).

The pointer is moved by a stepper motor. The engine speed signal goes from the DME (ECM) via the PT-CAN to the ZGM and from there via the K-CAN System to the instrument cluster.



Indicator and Warning Lamps

The indicator and warning lamp are arranged in fixed positions between and beside the pointer instruments in the instrument cluster. For activation, the symbols are given background lighting (LEDs) in one or more colors. This enables display of symbols depending on the degree of importance in red, yellow, green or blue. The legally required and standardized indicator and warning lights include:

- Turn indicators
- High beam headlight
- Seatbelt warning
- Airbag
- General brake warning
- Rear fog lights, fog lights
- OBD II Check Engine (MIL)



There are also indicator and warning lights for:

- Dynamic Stability Control (DSC)
- Program display of the automatic gearbox

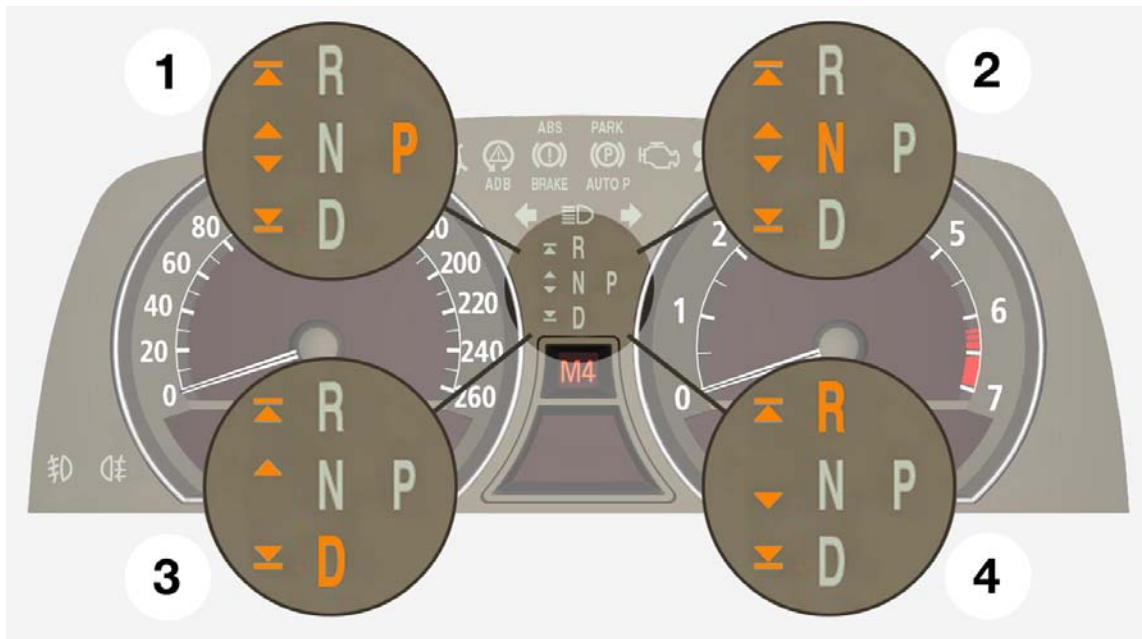

The arrows beside the program display indicate each of the possible directions of movement of the transmission selector lever. The program display remains illuminated for 10 seconds after the remote control has been removed (after-run function).

When the engine has been switched off (KL15 OFF) and drive position N selected, the program display remains active for up to 30 minutes. This indicates to the driver possible incorrect operation of the selector lever on parking the vehicle (position P not engaged). After 30 minutes have elapsed, the parking lock is activated automatically. The entire control of the program and gear display is handled by the EGS control unit.

All other indicator and warning information is provided in a corresponding symbol display in the variable warning field.

Notes:

Illumination and Dimming

The background light of the display areas and the lighting of pointers and dials is provided by orange LEDs. The light emitting diodes are designed to last the service life of the vehicle and cannot be replaced separately.

The individual display areas are only illuminated when there is a message displayed in the relevant display area. However, for reasons of visual appearance, two adjacent display areas are always illuminated at the same time.

The pointers and dials are only illuminated when the lights are switched on and they serve as a function indicator for "driving light ON". The brightness of the LCD display as well as all indicator and warning lamps is adapted to the lighting conditions in each case using a phototransistor.

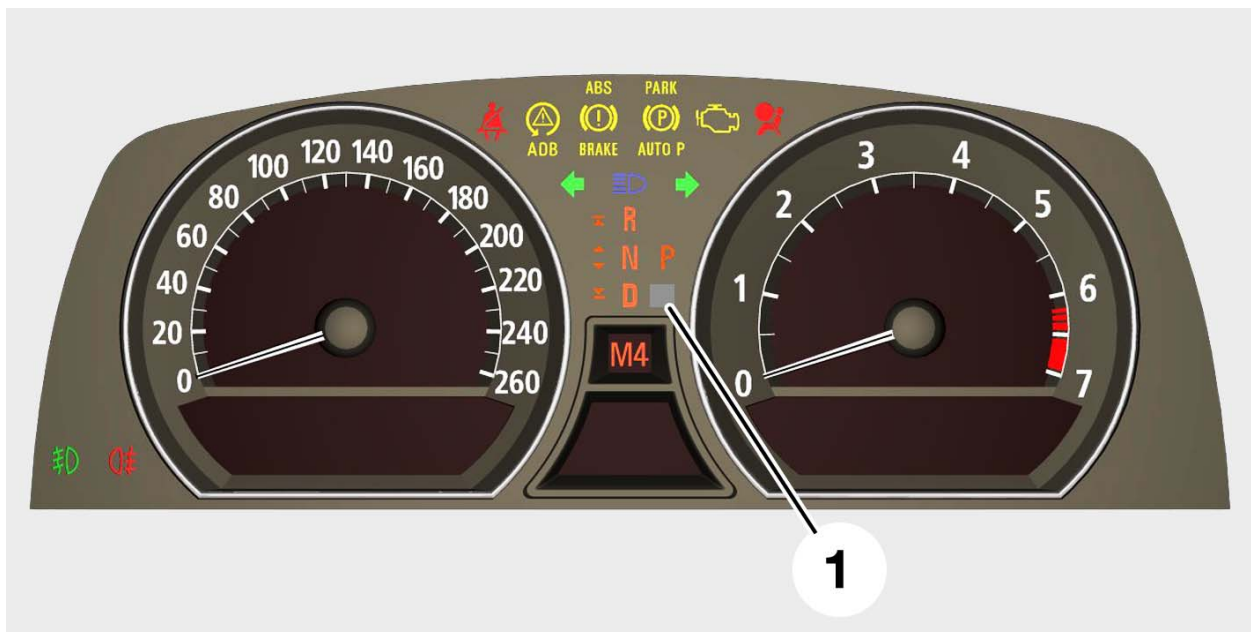

The brightness signal is calculated in the instrument cluster from the values of the phototransistor (1) and the dimmer wheel. This brightness signal is also made available via the K-CAN System to other control units in the vehicle. The instrument cluster is thus used as the "dimming master".

The contrast setting of the LC display is automatic, depending on age and temperature. For the temperature compensation, an NTC resistor is fitted to the LC display. The contrast voltage is then determined according to the temperature by the electronics in the instrument cluster.

In order to take account of ageing over time, a counter is installed in the instrument cluster to record the operation time by the hour. With increasing age of the LC display, the contrast voltage is adapted to maintain a consistent contrast.

Turn Signal Acoustic Feedback

The turn signal acoustic feedback is output through a loudspeaker integrated in the instrument cluster.

All other acoustic signals are generated by the Audio System Controller ASK and output through the vehicle loudspeakers.

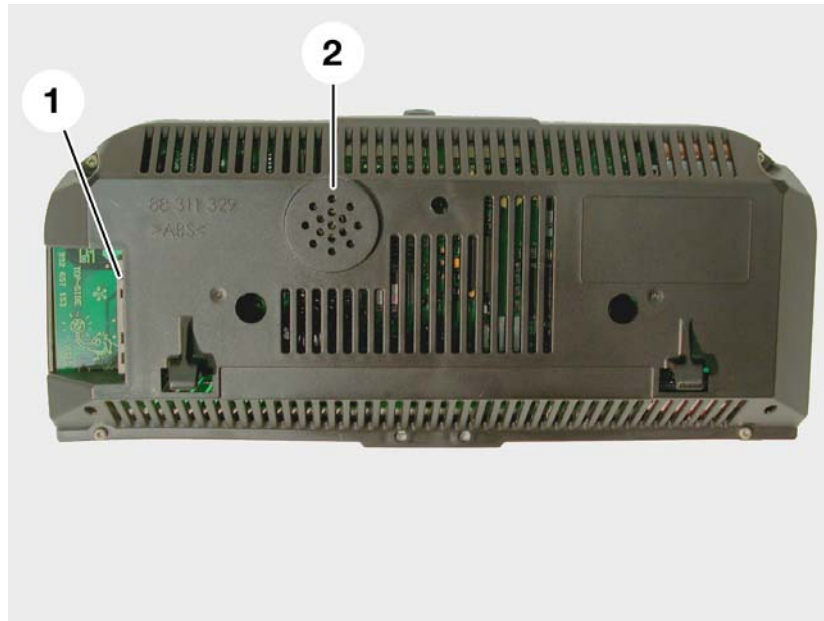

Trip Odometer Reset Button

The trip odometer reset button is located in the top left-hand corner of the instrument cluster; it takes on the following functions:

- With the ignition switched off, brief pressing of the button displays the total mileage, the trip odometer, the time and outside temperature for 8 seconds. If the button is pressed once again within this time window, the trip odometer is reset.
- Pressing the button for longer than 2 seconds displays the ABS symbol for 2 seconds in the variable warning field.
- Activation of the test functions.
- Resetting the service requirement display SBA

Input and Output Signals

The connection of the instrument cluster to the vehicle electrical system is by means of a 20-pin Elo connector. For the MOST bus, two additional contacts are fitted (2). The pins for the K-CAN System are located in the 20-pin Elo connector.

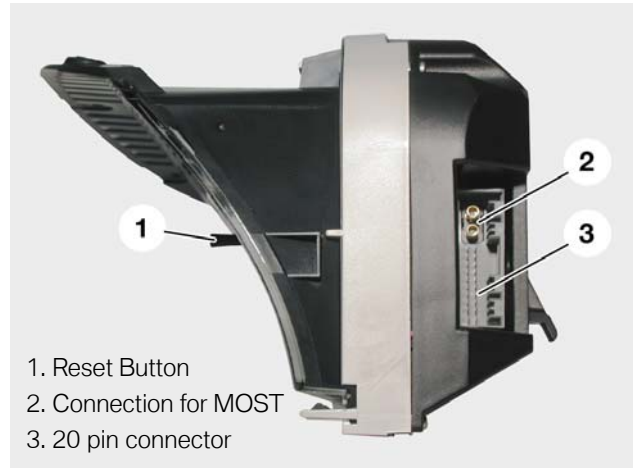

1. Reset Button
2. Connection for MOST
3. 20 pin connector

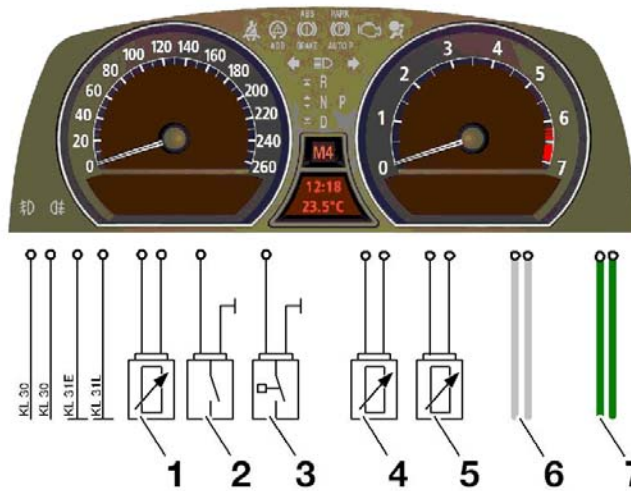

Index	Explanation	Index	Explanation
1	Outside temperature sensor	5	Fuel tank sensor, right
2	Washer fluid level sensor	6	K-CAN-System
3	Coolant level sensor	7	MOST Bus
4	Fuel tank sensor, left		

The connections of the outside air temperature sensor, washer fluid level sensor, coolant level sensor and the fuel-tank sensor are hardwire inputs to the instrument cluster.

All other information/requests to or from the instrument cluster are transferred as data telegrams across the bus connection. The instrument cluster is connected to the vehicle communication system via the K-CAN System and the MOST.

I-P-O

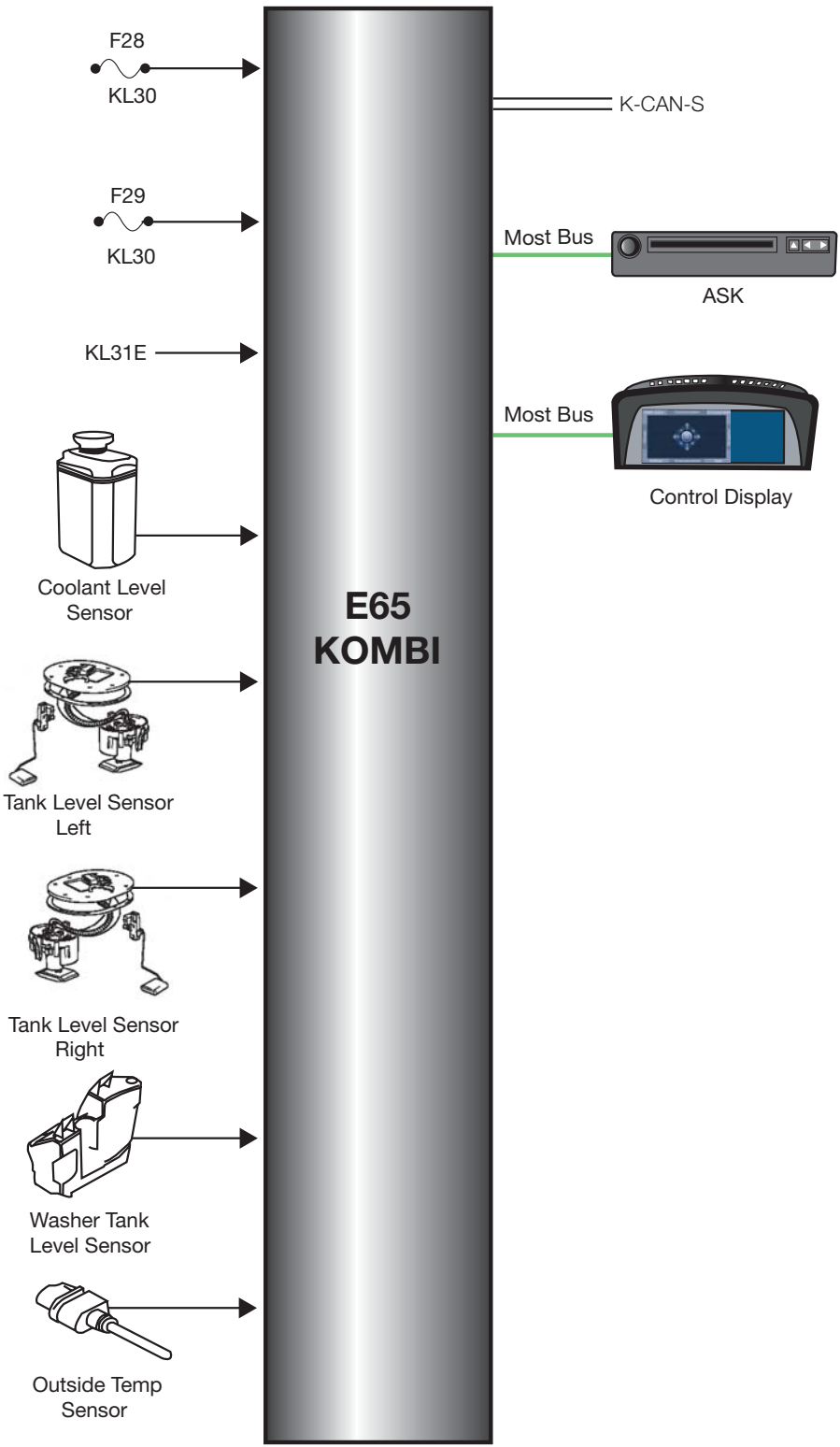

K-CAN System Telegrams

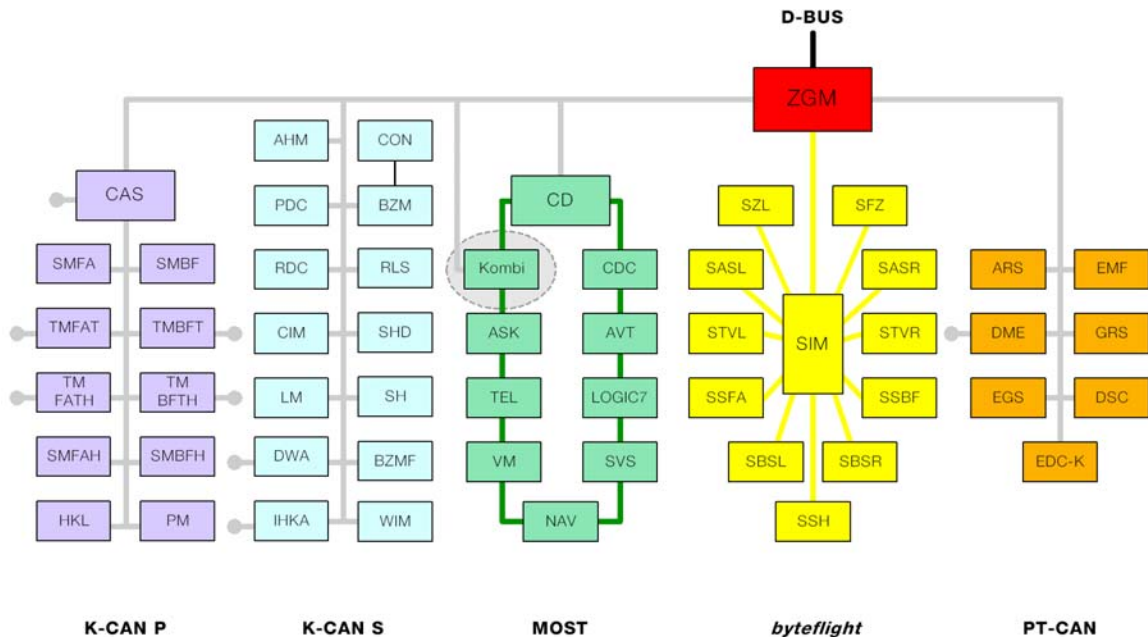

The communication with control units in the chassis, power train and body areas is via the K-CAN System.

Via the K-CAN System, the following input and output signals are transferred in the form of telegrams:

Speed

This telegram is required for the display of the vehicle speed and the calculation of the distance driven. The signal from the left-hand rear wheel sensor processed by the DSC control unit is used. The speed telegram goes from the DSC control unit via the PT-CAN to the ZGM (Central Gateway Module) and from there via the K-CAN System to the instrument cluster.

Gearbox Data

Via this telegram, the instrument cluster receives the following gearbox data from the AGS control unit:

- Gear position
- Driving program
- EGS error messages

This data is used to display the gear position, the selected driving program and CC messages. The gearbox data telegram goes from the AGS control unit via the PT-CAN to the ZGM (Central Gateway Module) and from there via the K-CAN System to the instrument cluster.

Engine Speed (RPM)

The engine speed telegram goes from the DME(ECM) via the PT-CAN to the ZGM (Central Gateway Module) and from there via the K-CAN System to the instrument cluster.

Outside Temperature

The input value of the temperature sensor is computed in the instrument cluster against the current engine temperature and the vehicle speed. This ensures that the outside temperature signal is not excessively influenced by the air flow or the engine heat. The instrument cluster makes this outside temperature value available to the other control units (e.g. CD, IHKA) as a telegram via the K-CAN System.

CBS Messages

These telegrams are sent by the following components - which monitor their own wear parts within the framework of Condition Based Service CBS - to the instrument cluster:

- DME (ECM)
- DSC
- IHKA

These signals contain the current degree of wear of each component and are used in the instrument cluster for calculation of the CBS displays and service dates.

Bus Status

The ZGM informs the instrument cluster about the status of the K-CAN System, (e.g. bus active, bus in idle state).

Dimming

This signal comes from the dimmer wheel and is sent by the light module LM via the K-CAN System as a telegram to the instrument cluster.

Driver Display, Speed Range

This telegram is routed from the DME (ECM) via the PT-CAN to the ZGM and from there via the K-CAN System to the instrument cluster. The signal is used to show the variable engine speed warning field in the display of the instrument cluster.

Parking Brake (EMF)

The telegram for the parking brake indicator lamp is routed from the EMF control unit via the PT-CAN to the ZGM and from there via the K-CAN System to the instrument cluster.

Vehicle Identification Number

This telegram is routed from the Car Access System (CAS) via the K-CAN System to the instrument cluster and it contains the last seven digits of the vehicle identification number.

The vehicle identification number must be specified within the framework of the redundant data storage for the allocation of instrument cluster to vehicle.

Vehicle Type

This telegram is routed from the Car Access System CAS via the K-CAN System to the instrument cluster and it contains the following details of the vehicle type:

- Model series
- Body type
- Gearbox
- Engine type
- Steering
- Country-specific version

This enables an allocation between the various vehicle versions and the instrument cluster.

Mileage Reading/Range

This telegram is made available by the instrument cluster via the K-CAN System to other control units. It contains the following details:

- Total mileage
- Tank level status, right, left, total, reserve
- Calculated range

These details are required for creation of fault code memory entries in other control units.

Terminal Status

This telegram is routed from the CAS via the K-CAN System to the instrument cluster and it contains details of each terminal status:

- Status terminal R
- Status terminal 15
- Status terminal 50
- Status key in ignition

Lamp Status

This telegram is routed from the LM via the K-CAN-System to the instrument cluster and it contains details of each lamp activation:

- Status high beam/headlight flasher
- Status parking light
- Status fog lights
- Status rear fog light

LCD Brightness

This telegram is calculated from the value of the phototransistor and the dimmer wheel. It is routed from the instrument cluster via the K-CAN System to the control units: CDC, SZL and LM, it is used by these control units as a dimming signal.

Engine Data

This telegram is routed from the DME (ECM) via the PT-CAN to the ZGM and from there via the K-CAN System to the instrument cluster; it contains the following details:

- Engine temperature (coolant temperature)
- Engine oil temperature
- Engine oil pressure
- Alive counter of the DME (function monitoring of DME)
- Status engine running
- Injection rate (total of supplied volume of fuel)

Network Management K-CAN

This telegram is transmitted and received by every control unit. For this purpose, each control unit has a corresponding control unit address that it uses for transmission and by which it recognizes a network management message.

RDA Request/Data Storage

Via the K-CAN System, the instrument cluster requests the current data from the redundant data storage in the CAS. The same telegram is used to transfer the latest data of the instrument cluster to the CAS.

Cruise Control

This telegram is only sent by the DME when no ACC is installed; it contains the following information:

- Current control speed
- Status of the cruise control (off/activated)
- Display of speed marks

Power Management Battery Voltage

This telegram is routed from the Power Module via the K-CAN-P via the K-CAN System to the instrument cluster and it contains the following details:

- Battery voltage
- Status battery main switch

Relative Time

This telegram is made available to other control units by the instrument cluster for time calculations. A timer counts the seconds synchronous to the system/vehicle clock. This signal can be used to measure relative times. The clock cannot be used for this purpose, as it can be set by the customer.

The counter runs following reset (e.g. disconnecting the battery) from 0 and counts in second increments from 0 to over 4 billion, which corresponds to approximately 140 years.

The DME (ECM), for example, needs the relative time to determine the immobilization period of the engine (engine OFF) and thus to improve the starting capability of the engine. The immobilization period is calculated by the DME (ECM) from the relative time of terminal R OFF to terminal R ON again.

Status Damper Program

This telegram is routed from the Electronic Damper Control-continuous (EDC-K) via the PT-CAN to the ZGM and from there via the K-CAN System to the instrument cluster.

If the EDC-K fails, active output of error messages is no longer possible. Monitoring means the instrument cluster is able to detect failure of the EDC-K and to display a corresponding Check Control message.

Status DSC

This telegram is routed from the Dynamic Stability Control DSC control unit via the PT-CAN to the ZGM and from there via the K-CAN System to the instrument cluster, informing it of the status messages of the DSC program and error messages.

Alive Counter EMF

This telegram is routed from the electro-mechanical parking brake EMF control unit via the PT-CAN to the ZGM and from there via the K-CAN System. It serves as function monitoring of the EMF by the instrument cluster. If the parking brake control unit fails, active output of error messages is no longer possible. Monitoring means the instrument cluster is able to detect failure of the parking brake control unit and to display a corresponding Check Control message.

Time/Date

This telegram is made available by the instrument cluster via the K-CAN System to other control units and it contains details of the date and time. The wiper module, for example, needs the information date/time to calculate the alternating rest position for the wiper system.

Status Radio-Control Key

This telegram is routed from the CAS control unit via the K-CAN System to the instrument cluster and it contains the following details:

- Personalization number of the radio-control key
- Status key battery

Status Instrument Cluster

This telegram is routed from the instrument cluster to the control units, DME, SIM and wiper module, it contains the following details:

- Displayed vehicle speed
- Unit of speed kmh/mph
- Fill level, washer fluid
- Status interface cruise control
- Status airbag warning lamp
- Relative time counter
- Status seatbelt warning lamp
- Status engine warning lamp
- Status DSC indicator lamp
- Status brake warning lamp
- Status parking brake indicator lamp

Central Locking System and Trunk Lid Status

This telegram is routed from the CAS control unit via the K-CAN System to the instrument cluster and it contains the following details:

- Status central locking system
- Control central locking system
- Status door contacts and trunk lid

These signals are required by the instrument cluster for the display of the CC message regarding the positions of doors, trunk lid and central locking system.

MOST Bus

The data connection to the following control units in the communication area is via the MOST bus:

- Navigation system
- Audio System Controller (ASK)
- Speech Processing System (SVS)
- Control Display (CD)

Notes:

Check Control

Until now, the Check Control has been a reporting system for vehicle faults. For the E65, the scope of functions has been extended considerably. It now also displays operating statuses and provides detailed instructions. This provides the driver with valuable assistance, enabling the appropriate reactions in the event of a system failure or fault, despite the increasing complexity of the vehicle electronics.

In the E65, the number and information content of the messages have increased considerably in comparison to the E38:

- Most CC messages contain a unique instruction, telling the driver what to do.
- The message texts are more detailed (40 characters instead of 20 in the E38).
- Parallel to the CC message, the On-Board data menu of the Control Display contains more detailed information (up to 170 characters!) regarding the current message. In the case of particularly important messages, this appears automatically.
- The combination of text and graphic ensures faster assimilation of the information on the part of the driver.
- The number of warning indicator lamps in the instrument cluster has been drastically reduced; many of them have been replaced by more informative CC messages with variable indicator lamps. Warning lamps are now only used where this is legally required.
- The Check Control is easy to expand, as the evaluation of the message conditions for the individual functions and systems has been shifted to the relevant control unit in each case.
- The coolant-temperature gauge in the E65 is no longer a separate instrument, but a function of the Check Control. It is only displayed when required.

Display Locations

The messages of the Check Control are displayed in three locations.



The variable graphic icons are displayed in yellow or red in display area 5 below the gear display. Normally, the time and outside temperature are displayed in this area, these can be overwritten by the Check Control where required.

The text messages of the Check Control appear in display area 4 below the tachometer. If data from the On-Board computer is displayed here while a message is being issued, it is overwritten by the Check Control.

For most of the messages of the Check Control, there are also supplementary explanations and instructions. These can be opened on the Control Display via the On-Board Data menu. In the case of priority 1 messages, they appear automatically.

Check Control messages are most times announced by a gong.

Display Characteristics

All messages of the Check Control are triggered by the control units responsible for the monitored function and transferred as data telegrams via the MOST bus or the K-CAN System to the instrument cluster.

From there, they are distributed, depending on requirements to the individual output locations (within the instrument cluster or via MOST to the Control Display).

Each individual CC message is assigned characteristics that control its display features.

At this point a distinction is made between text messages (in addition to an indicator lamp, an accompanying text also appears in the Check Control and possibly also on the Control Display) and non-text notifications (a warning LED or graphic icon lamp lights up).

All the message texts are stored together with the characteristics in a table in the instrument cluster. In the event that a number of messages are output at one time, the message with the highest priority is displayed first. The same applies when different non-text indicators want to light up the same warning lamp.

In addition to the visual display, the Check Control also uses acoustic signals. A gong or double gong are generated by the Audio System Controller (ASK). The gongs have different tones depending on the importance of the associated message. The gong can be generated every time the CC message is re-displayed or only once during the initial appearance of the message

The acoustic signals are output, depending on the reason for the warning, via the front left-hand and/or right-hand vehicle loudspeakers.

Operation

The messages of the Check Control are automatically displayed in display area 4 and 5 of the instrument cluster. If these display areas already contain data at the time a fault occurs (e.g. from the On-Board Computer), this is overwritten by the Check Control.

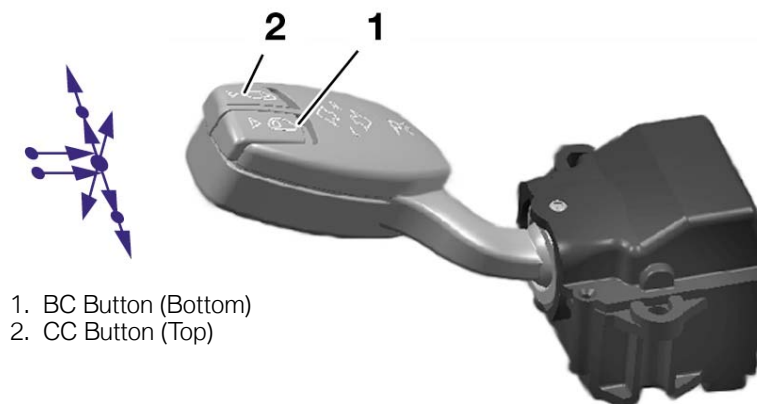

The CC button in the turn signal stalk can be used to browse through all the CC messages issued (press briefly), or to toggle between the On-Board Computer and Check Control in the display area below the tachometer.

Eight seconds after the last touch to the button, the display switches back automatically to the initial state (darkened or On-Board Computer).

Darkening is not possible when a message of priority 1 is displayed in the Check Control (e.g. engine overheating), or the fuel gauge is at reserve.

On-Board Computer (BC)

The On-Board Computer in the E65 is not only a trip computing system; it also provides the driver with important vehicle information.

New Features

The fuel tank contents, current consumption, total mileage and trip odometer, which have until now been displayed in separate, fixed-position displays in the instrument cluster, are now integral parts of the On-Board Computer.

They are scrolled through as items of information and only displayed when the driver actively requests them.

Only the fuel gauge is automatically displayed as soon as the reserve level is reached. Most of the data for the On-Board Computer is transferred by control units in digital form via the K-CAN System to the instrument cluster, where it is processed and displayed in the instrument cluster itself or in the Control Display (transfer to that point by MOST telegram).

Coolant level, wiper fluid levels and the outside temperature are signaled to the instrument cluster by hardwire.

The tank level is reported in redundant form by two independent analog direct lines to the instrument cluster.

In the case of average values, only dashes are displayed until the wheel speed signal arrives. The wheel speed signals are reported by the sensor of the left-hand rear wheel via the DSC control unit per K-CAN System to the instrument cluster. If this sensor is defective, the right-hand rear wheel is used.

All texts for the On-Board Computer are stored in the Control Display. The corresponding numerical values are provided by the instrument cluster via MOST. The information memory for consumption and travel distances is also located in the instrument cluster.

The On-Board Computer in the Control Display is operated by means of the Controller on the center armrest.



It consists of the following sub-functions:

- "Main" on-board computer, referred to simply as the On-Board Computer. Its information can be called up and scrolled as in previous models by pressing the turn signal switch and viewing the display in the instrument cluster.
- Travel Computer. This computer is used to monitor one or more parts of a trip; its information can only be displayed in the Control Display.
- Stopwatch and limit. These can also, like the travel computer can only be displayed in the Control Display, but they can be activated directly in the main menu "On-board computer".
- Setting menu for independent ventilation, clock/date and memory signal are activated using the entry "Settings" in the main menu "On-board computer". The "units" selection for the entire scope of the on-board computer are also located here.

Not all functions of the On-Board Computer that are displayed in the Control Display can also be displayed in the instrument cluster; only those of the "main" On-Board Computer can do this.

However, the functions of the On-Board Computer that cannot be displayed in the Control Display can only be displayed in the instrument cluster (fuel gauge, total mileage, trip distance).

On-Board Computer



- **Distance** - Entered manually using the controller and then computed (counted down) by the instrument cluster or transferred by the navigation system via MOST to the instrument cluster. In this case, the navigation system handles the calculation up to the position "0"; from then on (minus distance), the instrument cluster continues the count in both cases.
- **Range** - Calculated from the average fuel consumption figure and the tank contents. A calculation compensates for idle periods with the engine running or sudden changes in driving style. The average fuel consumption figure is a calculated result which, depending on the driving situation, revises the current fuel consumption over a given period. This ensures that the calculated results are plausible and that large jumps are avoided if vehicle handling changes suddenly.
- **Arrival time** - Calculated from distance, time and an average speed. Here, too, the calculation method ensures equalization of the average speed so that there are no larger jumps in time; the displayed value grows or shrinks minute by minute. The arrival time can only be calculated when the clock has been set and a distance entered. If no distance is entered manually, but is adopted from the navigation system, there is a permanent alignment with the route guidance on the basis of the roadmap data. The result is a significantly more precise prediction of the arrival time.

- Average fuel consumption - The calculation interval always begins with a manual reset; the display appears after arrival of the speed signal . The basis of the calculation is the data from the consumption and travel memory.
- Average speed - Here, too, each calculation interval begins with a manual reset; the display appears after arrival of the speed signal. The basis of the calculation is the data from the consumption and timer.

The reset of average fuel consumption and speed is by means of the controller, directly in the menu of the on-board computer in the Control Display. When one of these displays is selected, a dialog window appears on the screen to enable a selective reset.

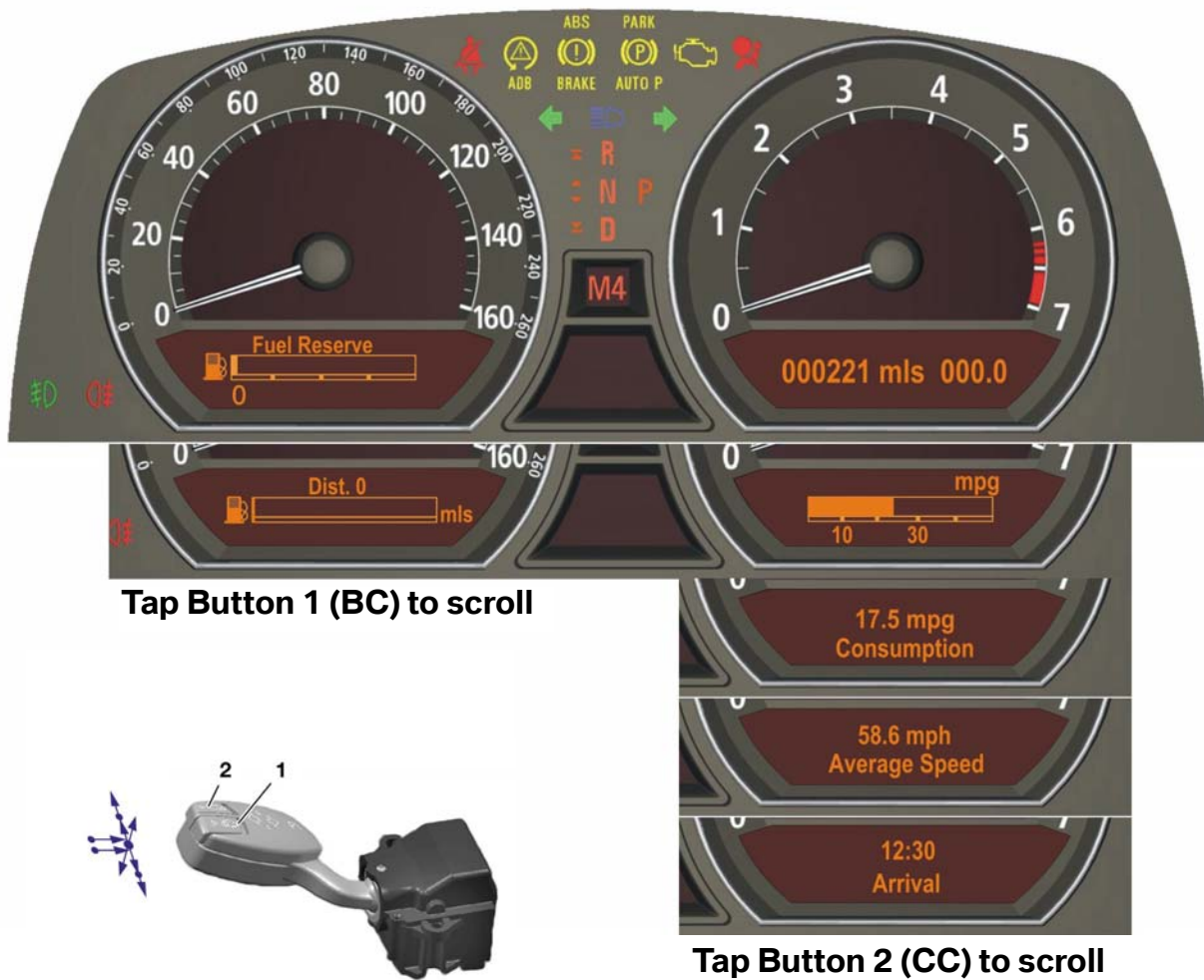

Individual items of information of the On-Board Computer can also be displayed in the instrument cluster:

- Distance
- Fuel gauge (tank contents can only be viewed in KOMBI)
- Range

(The previous items can be displayed in the display field below the speedometer.)

- Arrival time
- Average fuel consumption
- Average speed
- Total mileage
- Distance to destination
- Current consumption

Note: Can only be viewed in the cluster

(The previous items can be displayed in the display field below the tachometer.)

The functions Stopwatch, Limit and Memo as well as the timer for independent ventilation are only provided in the Control Display. They cannot be displayed on the instrument cluster.

When the vehicle is started, the information that was last selected will be displayed. If the display area below the tachometer contains a Check Control message, no function of the On-Board computer is displayed there.

The displays of the On-Board Computer are scrolled and shown in the instrument cluster by means of buttons in the turn signal stalk. Pressing and holding the top (2) button toggles between Check Control and On-Board Computer in the display area below the tachometer. Briefly tapping scrolls through its functions.



Briefly tapping the lower button (1) scrolls all the display options in the display area below the speedometer.

Pressing and holding darkens both display areas. Darkening is not possible when a Check Control message is active or the fuel gauge is at reserve. A single display area cannot be darkened, the fields are always active or dark as a pair.

Travel Computer

The travel computer is used to monitor individual stages of a trip. It must be selected and activated separately in the On-Board Computer menu in the Control Display.



The travel computer displays the starting time and date, driving time, distance travelled, average fuel consumption and average speed exclusively in the Control Display.

The travel computer information cannot be displayed on the instrument cluster. The "START" button, selected using the controller activates the travel computer. If a trip is interrupted, the calculation of the average values is stopped as of terminal 15 Off (unless START or STOP are activated) and only continued when the trip is resumed.

The "STOP" button freezes the displays. Selecting "START" again resets all the displays of the travel computer; a selective reset of an individual functions is not possible in the travel computer.

Limit

A speed limit can be entered in the On-Board Computer, and a warning is triggered when the limit is exceeded.



The range above this speed is displayed with a bright bar segment within the speedometer dial in the LCD area of the speedometer.

The limit can either be entered manually or the current driving speed can be adopted as the limit; both take place using the Controller and Control Display.

The function is ready for operation and input as of terminal R On, but the limit warning can only be triggered during driving (terminal 15 On and incoming speed signal telegram).

The instrument cluster saves the current speed limit and the corresponding activation state, even after terminal R Off. If the limit entered is exceeded, a gong sounds and a message appears in the Check Control.

The information on the limit and activation state is reported by the Control Display to the instrument cluster per MOST telegram and stored in the instrument cluster.

Stopwatch

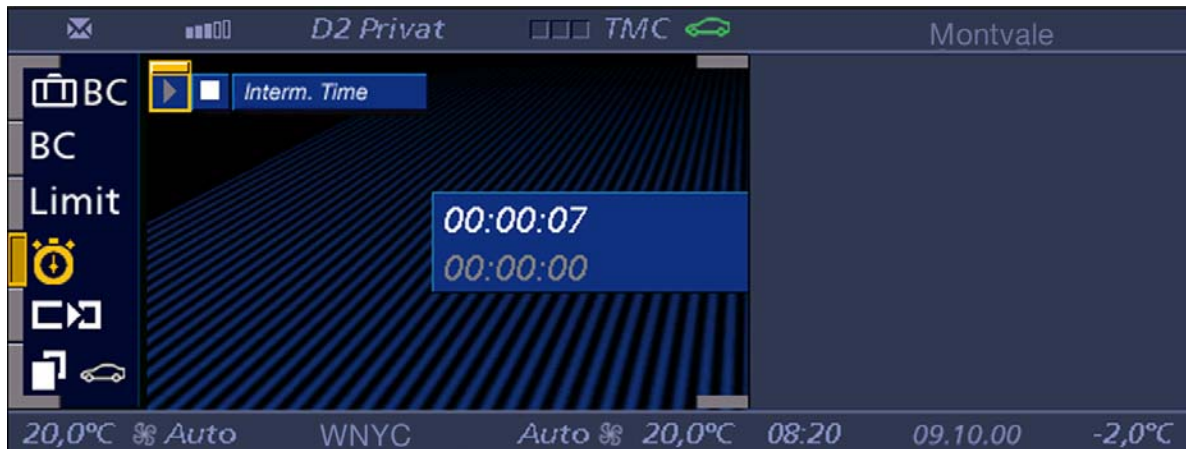

The stopwatch is ready for operation as of terminal R. A stopwatch that is running is stopped at terminal R Off and restarts at terminal R On.

The maximum runtime is 99 hours and 59 minutes. The stopwatch is started and stopped using selection buttons in the Control Display.

When the stopwatch is running, an intermediate time can also be called up.

Settings

The following additional functions can be controlled using the On-Board Computer in the Control Display:

Clock

The calculation of the time takes place in the instrument cluster. Time is also displayed in the Control Display (transmission per MOST telegram). The time cannot be displayed in the instrument cluster as an On-Board Computer function.

The time is located together with the outside temperature in the LCD display field below the gear display, (unless it has been overwritten by a variable indicator lamp of the Check Control).

Memo Signal

If MEMO is activated, the instrument cluster triggers an hourly reminder signal via ASK 15 seconds before each full hour.

The signal can be activated and deactivated on the Control Display, assuming a time has been set. The MEMO signal is only triggered as of terminal R On.



Workshop Hints

Redundant Data Storage

In the event of repairs, it is necessary that the mileage reading and the data for the CBS intervals be stored on replacement of the instrument cluster.

The following data in the Car Access System CAS is redundant:

- Vehicle identification number
- Total mileage
- CBS data

Every time terminal 15 is switched on, a data check takes place. In order to detect manipulations, an orange dot (manipulation dot) is shown in display area 4 below the

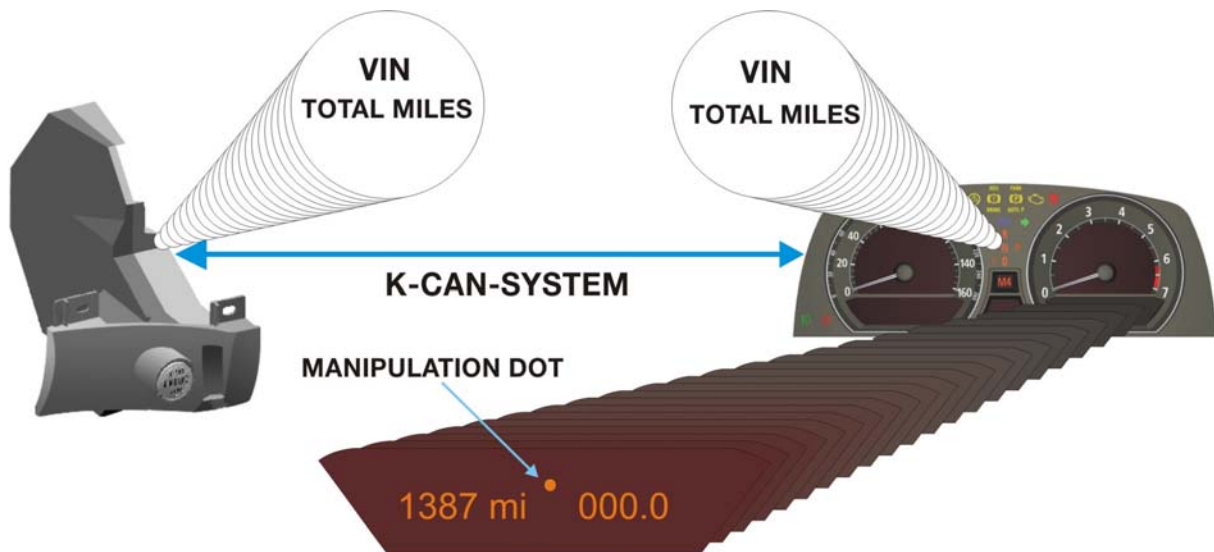

tachometer.

The manipulation dot is set under the following conditions:

- The vehicle identification number stored in both control units does not match.
- In one of the two control units, no vehicle identification number is stored, e.g. new component.
- The component for storage of the total mileage in the instrument cluster is defective, (the display for the mileage reading shows 999999).

Installation of a New Instrument Cluster

The manipulation dot is set when KL 15 is switched on because the vehicle identification number is not coded in the instrument cluster.

The instrument cluster is now assigned to the vehicle using the BMW diagnosis unit (GT-1 or DISplus) by means of coding, (i.e. the vehicle identification number is entered in the instrument cluster).

Switch off terminal 15.

When KL 15 is switched on again, the instrument cluster requests the current mileage and CBS data from the CAS. The manipulation dot is extinguished.

Installation of a New or Used Instrument Cluster for Test Purposes

Although the vehicle identification number (Kombi/CAS) differs and has not yet been entered in the instrument cluster, there is bi-directional communication between the instrument cluster and the CAS.

For example, the mileage reading stored in the CAS is transferred into the working memory for the total mileage display in the instrument cluster and displayed. If there is now a test drive, the distance driven is counted in the working memory of the total mileage and transferred every 10 kilometers (E38 every 100 kilometers) to the CAS.

If at least 24 hours have elapsed between switching terminal 15 on and off, another calibration is performed, independent of the distance driven. If the instrument cluster is removed following the test drive, the working memory loses the stored distance reading. This data is not stored, (the instrument cluster is returned to its initial state).

Note: In the case of a used instrument cluster (vehicle identification number is entered), the vehicle identification number can be overwritten up to a kilometer reading of 254 km (158mi). A reset of the permanently stored mileage reading is not possible.

Simultaneous Replacement of CAS and Instrument Cluster (new)

Where possible, this should be avoided, as the current mileage reading and all the CBS data are irretrievably lost! If both control units have to be replaced at one time, the following installation sequence is recommended:

1. Replacement of the instrument cluster.
2. Coding of vehicle identification number.
3. Terminal 15 OFF/ON (possible data transfer).
4. Replacement of the CAS.
5. Coding of vehicle identification number.
6. Terminal 15 OFF/ON.

When terminal 15 is switched on again, the manipulation dot is deleted. The communication between the instrument cluster and the CAS for redundant data storage is now restored.

In summary, the following apply in the case of replacement of CAS or instrument cluster:

- The manipulation dot is set if the vehicle identification number in the CAS differs from the vehicle identification number in the instrument cluster.
- If the vehicle identification numbers are different, data exchange takes place in the working memory of the instrument cluster; however, no data is stored permanently.
- The instrument cluster adopts the data from the CAS if the CAS has a higher mileage reading than the instrument cluster and the vehicle identification numbers match.
- The CAS adopts the data from the instrument cluster if the instrument cluster has a higher mileage reading and the vehicle identification numbers match.
- The mileage is transferred from the instrument cluster to the CAS every 10 km of the journey. If at least 24 hours have elapsed between switching terminal 15 on and off, another calibration is performed, independent of the distance driven.

Instrument Cluster Test Functions

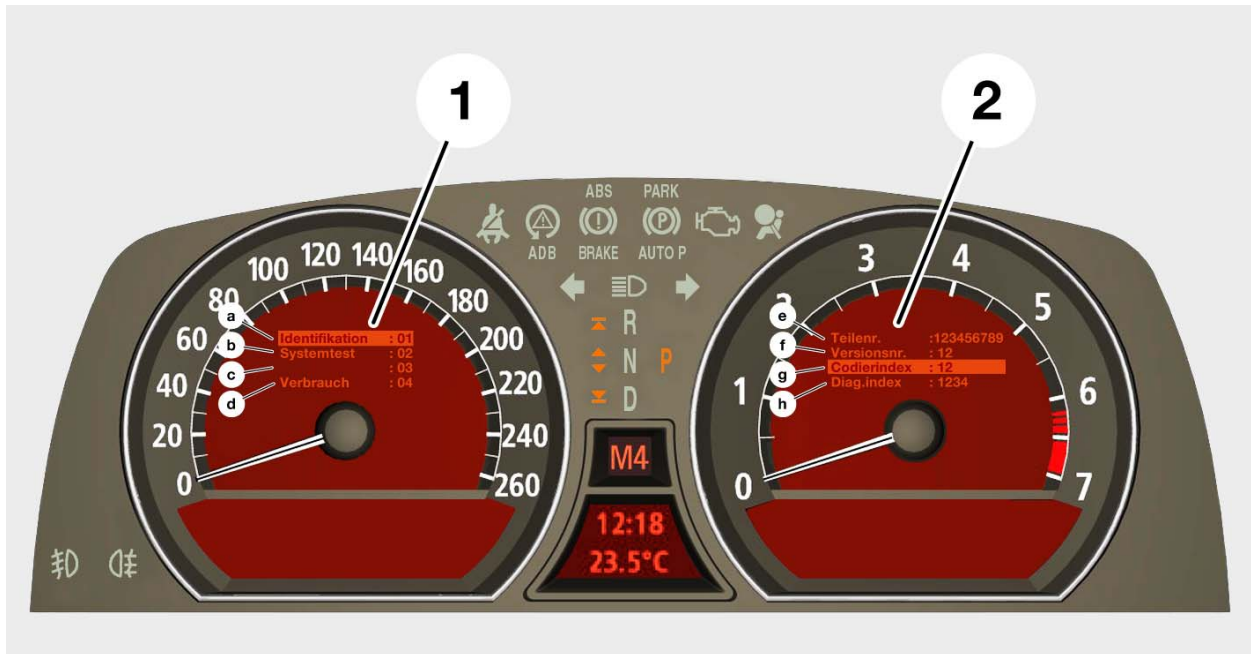

The instrument cluster of the E65 has 21 test functions that can be read out of the LCD display areas 1 and 2.

The test functions can be displayed at terminal R (radio position) or at terminal 15 “ON”. The test functions are started by pressing the trip odometer reset button. Keep the button pressed for longer than 5 seconds. First the SBA reset will be displayed, continue holding until the test functions appear.

There is another possibility to start the test functions. With terminal R switched “OFF”, hold down the trip odometer reset button and then switch terminal R “ON”.

In the left-hand display area (1) inside the speedometer, the following appears:

Identification :01
System test :02
(Not used) :03
Consumption :04

A maximum of 4 test functions can be displayed at one time in the menu. Each brief press of the trip distance reset button scrolls through the available test functions.

Tests one and two are unlocked. All other tests are locked and must be unlocked by means of test function number 19. It is only possible to unlock the test functions by entering a code. The required input code is calculated from the total of the last 5 digits of the vehicle identification number stored in the instrument cluster e.g. $1+2+3+4+5= 15$.

Starting a Selected Test Function:

Pressing the reset button >2 seconds starts the selected test function (e.g. system test:02).

The display or sub-items of the selected test function appears in the display area (2) inside the tachometer.

To return to the test functions menu, hold the reset button again > 2 seconds.

The test functions are closed by switching off terminal R (radio position) or pressing the reset button for >6 seconds.

To prevent unauthorized access to the test functions, they have to be locked once again before they are closed (see test function 19).

Test function 01: Identification

The following list appears in display area 2 within the tachometer: a maximum of 4 lines can be displayed at one time. Brief pressing of the trip distance reset button enables scrolling down the list.

Part no.	123456789012
K-number v (1/KM)	44734
Version number	12
Coding index	12
Diagnosis index	1234
Variant index	1234
Identification	123456789
Production date	13.3.03
Manufacturer no.	12
Can-NK version	12. 12. 12
SW version	12. 12. 12
Standard Core	12. 12. 12
Slave SW	12. 12. 12
Bus_Ind. CAN	1234
Bus_Ind. MOST	1234

Test Function 02: System Test

The system test permits simple, visual assessment of the following functions in the instrument cluster:

- Pointer instruments
- Displays
- Backlighting of all displays
- Warning and indicator lamps

Activating this test function automatically activates the following components:

- All pointer instruments (pointers are moved over the display field)
- All LC displays with a segment test and their background lighting
- All indicator and warning lamps
- Variable indicator lamp (Check Control symbols)
- Gearbox program / gear display
- Turn signal indicators

Test Function 03: Not Used

Test function 04: Consumption

This test function must be unlocked before starting (see test function 19). This function is used to check consumption, even when the vehicle is stationary. The following list appears in display area 2 inside the tachometer:

Consumption 14.3 l/100 km

Stationary consumption 20.3 l/h

Test Function 05: Range Consumption, Current Range Value

This test function must be unlocked before starting (see test function 19).

The internal On-Board Computer cruising range consumption is used together with the average tank value to calculate the range.

The following list appears in display area 2 within the tachometer:

CR consumption	12.7 l/100 km
Range	238 km

Test Function 06: Fuel Tank and Displayed Value

This test function must be unlocked before starting (see test function 19).

In this function, the total tank contents and the contents of the left and right half of the tank are displayed separately. The following list appears in display area 2 within the tachometer:

Tank L, R, total,	29.5 l, 34.2 l, 63.7 l
Displayed value	60.2 l
Tank phase	1

Tank phase 1:

Normal calculation procedure via sensor, no error.

Tank phase 2:

Calculation from fuel consumption signal and/or CAN signal running (sensor fault). The fuel level indicator displays empty. Refuelling can no longer be recognized.

Tank phase 3:

No more calculation of the tank contents possible (at least 1 sensor defective, no fuel consumption signal). The fuel level indicator displays empty and the "fuel reserve" display is activated.

Test Function 07: Coolant Temperature, Outside Temperature, Dimming Photocell, Engine Speed

This test function must be unlocked before starting (see test function 19).

The current values for coolant temperature, engine speed, dimming photocell, and the current outside temperature at the sensor are displayed.

The following list appears in display area 2 inside the tachometer:

Engine coolant temp.	105 °C
Engine speed	2480 rpm
Outside temp.	+20.0 °C
Dimming	02E3 ADC

Test Function 08: Current Vehicle Speed

This test function must be unlocked before starting (see test function 19).

The current driving speed appears in display area 2 within the tachometer.

For example: V: 98 km/h

Test Function 09: Operating Voltage

The operating voltage available at the instrument cluster appears in display area 2 within the tachometer.

This test function must be unlocked before starting (see test function 19).

Test Function 10: Read Out Country Code

This test function must be unlocked before starting (see test function 19).

The currently set and selectable country codes/languages appear in display area 2 within the tachometer.

The languages are set using the Controller and CD.

Test Function 11: Read Out Units

This test function must be unlocked before starting (see test function 19).

The currently set and selectable units (AM/PM and/or mm.dd/ dd.mm etc.) appear in display area 2 within the tachometer. The units are set using the Controller and CD.

Test Function 12: Displays for Arrival

This test function must be unlocked before starting (see test function 19).

The average speed, displayed for calculation of the arrival time (OBC function DISTANCE), appears in display area 2 within the tachometer.

V arrival	136.5 km/h
Arrival time	23:46
Arrival date	2.2.03

Test Function 13: Trigger Acoustic Signals

This test function must be unlocked before starting (see test function 19).

When this test function is started, the following acoustic signals are triggered in succession. There is a break of 2.5 seconds after each signal.

- CCG (Check Control Gong 1X)
- DG (double gong)
- Hour signal
- Intermittent gong for 5 seconds
- 3 times turn indicator acoustic signal

Test Function 14: Self-Diagnosis

This test function must be unlocked before starting (see test function 19).

When this test function is started, a fault code memory table appears in display area 2 within the tachometer.

Occurring faults are output in this table in the form of fault codes (DTC).

These fault codes are not used for normal diagnosis.

Test Function 15: Display of I/O Port Statuses

This test function must be unlocked before starting (see test function 19).

When this test function is started, the statuses at the I/O ports (connections of the instrument cluster) appear in display area 2 within the tachometer.

Test Function 16: Display Test Bitmap

This test function must be unlocked before starting (see test function 19).

When this test function is started, a test bitmap (BMW logo), which can be used to check the positioning accuracy and state of the display, appears in display area 2 within the tachometer.

Test Function 17: Analog-Digital Converter ADC

This test function must be unlocked before starting (see test function 19).

When this test function is started, the following list appears in display area 2 within the tachometer.

Fuel-tank sensor 1	165	Ohm
Fuel-tank sensor 2	264	Ohm
Coolant level	001	ADC
Terminal voltage	11850	mV
Temp. outside	207/10	°C
Temp. glass(display)	32	°C
Phototr.	670	ADC
Gear	P5	ADC
Gear R	R885	ADC
Gear D	D885	ADC
Gear N	N885	ADC
Washer fluid	341	ADC

The analog-digital converter ADC values are primarily for the purposes of evaluation by vehicle development. Changes to the ADC values allow assessment of the function of components (e.g. phototransistor).

In the case of switches (e.g. coolant level sensor), the ADC value 0 = switch closed and the ADC value 1023 = switch opened.

Test Function 18: PWM Values

This test function must be unlocked before starting (see test function 19).

When this test function is started, the following list appears in display area 2 inside the tachometer:

Contrast display	4615
Background lighting	3148
Dimm. Gear	10000
Dimm. Ring	10000
Dimm. Warning field	10000

The contrast and dimming values are primarily for the purposes of evaluation by vehicle development. Changes to the values allow assessment of the activation of contrast and dimming.

The values are displayed from 0 (lowest value) to 10000 (highest value).

Test Function 19: Lock and Release Test Functions

All test functions, except for test functions one and two, are protected against unauthorized access. It is only possible to unlock the test functions by entering a code.

The required input code is calculated from the total sum of the last 5 digits of the vehicle identification number stored in the instrument cluster e.g. $1+2+3+4+5=15$.

To unlock the test functions:

1. Select test function 19. The following appears in display area 2 within the revolution counter:

LOCK: ON

CODE: 0

2. Enter the total sum of the last 5 digits of the vehicle identification number. The total is set by pressing the trip distance reset button and displayed in the field CODE: each press of the button increases the total number by one digit.

If the trip distance reset button is pressed more than 45 times, the total input number jumps back to 00. The total cannot exceed 45.

3. The input is acknowledged by pressing the trip distance reset button for longer than 2 seconds. Now, all the test functions have been enabled and can be selected using the trip distance reset button in the left-hand display area within the speedometer.

The test functions remain unlocked until they are locked again using test function 19.

To lock the test functions:

1. Select test function 19. The following appears in display area 2 within the tach:

LOCK: OFF

2. When the reset button is pressed, the following appears:

LOCK: ON

3. The input is acknowledged by pressing the trip distance reset button for a longer period.

Now all the test functions are locked again.

Test Function 20: Correction Factor for Average Consumption

This test function must be unlocked before starting (see test function 19).

This function is for checking and entering a correction factor for the fuel consumption figures.

When this test function is started, the correction factor for the average consumption appears in display area 2 within the tachometer.

Entry of the correction factor is only possible within the range of 750 to 1250. At production, the factor 1000 is stored in the EEPROM.

The correction factor is reduced by a numerical value of 1 with each brief touch of the reset button. Pressing the BC button on the turn signal stalk counts down in steps of ten to shorten the time required for the resetting procedure.

If the minimum value of 750 is reached, the display jumps to the maximum value 1250 and the counting resumes backwards.

The input is acknowledged by pressing the reset button on the instrument cluster.

The correction factor CC is calculated from the actual quantity of fuel consumed "CON ACT". and the displayed value "CON DIS":

$$CC = (\text{CON ACT.} / \text{CON DIS}) \times 1000 \text{ l/100 km}$$

Test Function 21: Software Reset/RAM Reload

This test function must be unlocked before starting (see test function 19).

This test function triggers a software reset and/or a RAM reload of the instrument cluster processor. During the software reset, all customer-relevant displayed values from the On-Board Computer, time, date and trip distance recorder are reset.

In the case of a RAM reload, the RAM is re-initialized, with the exception of the date and time. When this test function is started, the following list appears in display area 2 within the tachometer:

- RAM reload** ?
- SW RESET** ?

The RAM reload is started by pressing the reset button for > 2 seconds. A brief tap switches to the software reset, which is then triggered by another long press on the reset button.

If the test function is to be closed without triggering a RESET, the remote control must be removed or one of the two buttons (BC/CC) must be pressed on turn signal stalk.

Note: A software reset should be performed after replacement of a tank lever sensor or a temperature sensor, otherwise the dampening function in the software will only display the actual current value after a considerable delay.

Notes:

Resetting Condition Based Service (CBS) Display

When one or more service items have been carried out, (e.g. front and rear brake linings have been changed), these services must be reset to their full service interval.

This is accomplished using the Instrument cluster. In the future, it will be possible to do this with the Diagnostic tester.

- To reset a service, press the reset button on the top left part of the instrument cluster for more than ten seconds in KLR or KL15. This brings you directly to Reset mode.

Reset button -
Press and hold for
10 seconds



- A menu appears in the speedometer. At the top is the “Back” function, then the first three service items.



Service item menu

Reset mode for each individual service item is entered by pressing item in menu for greater than 2 seconds

The residual wear or the remaining time are specified (possibly with a minus sign).

The "!" symbol means that you can reset this service operation (early production vehicles may show an "F"), while a "0" indicates it is not re-set able (the first 20% of the service interval is also protected against accidental reset).

You can scroll through the service items by pressing the reset button or the lower button (CC button) on the turn signal switch.

When you have selected a service item, press the reset button > 2 seconds to display a 2-line menu in the tachometer.

The "Back" function is at the top, the re-set able service item is below it. Now select the service item with the reset button (or the CC button) and press and hold the reset button again.

In a third menu line, further down, the system confirms that the reset volume was successful.

The whole interval for the service operation is shown in the "Service Need Indicator " using the Control Display.

Notes:



Workshop Exercise - Instrument Cluster

Using an instructor designated vehicle, access the instrument cluster test functions and unlock the instrument cluster using proper test steps.

What number is entered to unlock the test functions? Record number below.

Continue to go through all test steps and familiarize yourself with the various information available.

How is test function 6 useful in diagnosis? What does “Tank Phase 2” indicate?

What is test step 21 and how is it useful in diagnosis?

Which test functions are always unlocked?

How is test function 2 useful in diagnosis?



Classroom Exercise - Review Questions

1. Where are fuel level and engine temperature displayed in the E65 Instrument Cluster?

2. Which components of the Instrument Cluster are separately replaceable?

3. What device is responsible for the gong tones?

4. How is Check Control information displayed in the E65?

5. How are the test functions of the Instrument Cluster called up? How many tests are there? How are the test functions unlocked?

6. How is the CBS reset procedure called up? Which control units assist the Instrument Cluster with the calculation of CBS data?

7. On the cruise control display on the speedometer, How many speed points can be displayed? (w/o ACC)







8. What can be shown in display area 5?





9. What three information items are stored redundantly between the instrument cluster and CAS?

10. Why should simultaneous replacement of the instrument cluster and CAS be avoided?











Notes:











Overview of Check Control Messages











Responsible Control Unit	Priority	Graphic Icon	Check Control Message	Instruction in Control Display	Gong
ARS	P2		Dynamic Drive Inactive	Dynamic Drive Inactive! Vehicle detects increased body roll in curves. Avoid high cornering speeds. Please contact your BMW center.	Yes
ARS	P1		Steering! Stop vehicle carefully	Switch off engine. Hazard from fluid loss in steering or suspension hydraulic system. Continued driving is not possible. Please contact BMW roadside assistance	Yes
ARS	P1		Dynamic Drive Inactive	Dynamic Drive Inactive! Vehicle detects increased body roll in curves. Avoid high cornering speeds. Please contact your BMW center.	Yes
ARS	P2		Dynamic Drive Inactive	Dynamic Drive Inactive! Dynamic drive is temporarily inactive. Increased body roll in curves. Avoid high cornering speeds.	Yes
CAS	P2		Door open!		Yes
CAS	P2		Door open!		Yes
CAS	P2		Door open!		Yes
CAS	P2		Door open!		Yes
CAS	P1		Hood open! Stop vehicle carefully	Accident hazard! Secure the hood	Yes
CAS	P2		Trunk open!		Yes
CAS	P2		Ignition failure! Stop vehicle carefully	No engine restart available. Continued driving is not possible. Please contact the BMW roadside assistance.	Yes











Responsible Control Unit	Priority	Graphic Icon	Check Control Message	Instruction in Control Display	Gong
CAS	P1		Starter! Leave engine running	Engine restart may be impossible. Please contact the nearest BMW center.	Yes
CAS	P2		Depress brake pedal to start engine		Yes
CAS	P2		Remote control battery! Charge	Remote control battery! - Charge Ignition lock automatically charges battery in remote control unit during extended vehicle operation.	Yes
CAS	P2		Remote control - No response	Remote control - no response! Remote control unit not present or defective, refer to Owner's Manual.	Yes
CAS	P2		Remote control battery discharged!	Remote control battery discharged! Replace battery of remote control with integrated key, refer to Owner's Manual.	Yes
CAS	P2		Child safety lock fault!	Child safety lock fault! Please contact your BMW center.	Yes
CAS	P1		Remote control! Do not stop engine	Remote control is not in ignition lock. This can make it impossible to restart engine. Please contact your BMW center.	Yes
CAS	P2		Next press of button starts engine!	Stay clear of rotating parts in engine compartment. Injury hazard!	Yes
CAS	P1		Remote control!	Remote control! Convenience entry mode deactivated. AUTO P not available with engine off. Take remote control when leaving vehicle.	Yes
CAS	P2		Remote control inside vehicle!	Remote control inside vehicle! It is not possible to lock and secure vehicle. Remove remote control from inside vehicle.	Yes
CAS	P2		Remote control missing!	Remote control missing! Remote control is not in immediate proximity of vehicle, rendering locking and security impossible. Keep remote control with you.	Yes











Responsible Control Unit	Priority	Graphic Icon	Check Control Message	Instruction in Control Display	Gong
CIM	P2		Servotronic malfunction! Drive moderately	Steering effort very light and sensitive. Please contact the nearest BMW center.	Yes
CIM	P2		Servotronic failure	Servotronic failure! Increased steering effort required. Please contact your BMW center as soon as possible.	Yes
DME(ECM)	P2		Cruise control inactive!	Cruise control inactive! Cruise control system is not operational. Please contact the nearest BMW center.	Yes
DME(ECM)	P3		Engine oil at minimum level!	Engine oil at minimum level. Add oil as soon as possible, refer to Owner's Manual.	Yes
DME(ECM)	P2		Engine oil level below minimum. Top off	Engine oil level below minimum. Add oil as soon as possible, refer to Owner's Manual.	Yes
DME(ECM)	P1		Engine malfunction! Reduced power	Engine malfunction! Reduced power - engine operating at reduced output. Drive moderately. Please contact the nearest BMW center.	Yes
DME(ECM)	P1		Engine! Stop vehicle carefully	Switch off engine. Potential engine damage. Continued driving is not possible. Please contact the nearest BMW center.	Yes
DME(ECM)	P2		Increased emissions!	Increased emissions! Emissions related fault. Please contact your BMW center as soon as possible.	Yes
DME(ECM)	P3		Please tighten filler cap!	Please tighten filler cap! Please check if filler cap is tightened.	Yes
DME(ECM)	P2		Engine malfunction! Drive moderately	Accelerate gently and drive slowly, avoiding high engine loads, as catalyst damage could result. Please contact the nearest BMW center.	Yes
DME(ECM)	P1		Engine overheated! Stop carefully	Switch off engine and allow to cool. Do not open hood: scalding hazard! Continued driving is not possible. Please contact BMW Roadside Assistance.	Yes



Responsible Control Unit	Priority	Graphic Icon	Check Control Message	Instruction in Control Display	Gong
DME(ECM)	P3		Oil Levels sensor failure!	Oil level sensor failure! Check engine oil level and top off as required, refer to Owner's Manual. Please contact your BMW center as soon as possible.	Yes
DME(ECM)	P1		Engine oil pressure! Stop carefully	Engine oil pressure too low. Switch off engine. Possible engine damage. Continued driving is not possible. Please contact BMW Roadside Assistance.	Yes
DME(ECM)	P2		Generator fault!	Generator fault! Battery is not being recharged. Switch off all non-essential equipment. Please contact the nearest BMW center.	Yes
DME(ECM)	P1		Engine temp. high! Drive moderately	If this reoccurs, please contact your BMW center.	Yes
DSC	P2		DSC inactive! Drive moderately	Reduced vehicle stability under acceleration and in curves. Please contact your BMW center as soon as possible.	Yes
DSC	P2		DSC inactive! Drive moderately	DSC Inactive! Drive moderately. Reduced vehicle stability under acceleration and in curves.	No
DSC	P1		Brake linings! Replace immediately	Brake linings worn to minimum depth. Accident hazard! Have this checked by the nearest BMW center.	Yes
DSC	P2		Brake fluid! Stop vehicle carefully	Brake fluid level too low. Reduced braking efficiency. Top off fluid in reservoir, refer to Owner's Manual. Please contact your BMW Center.	Yes
DSC	P1		DSC failure!		Yes
DSC	P2		DTC active!	DTC Active! Dynamic Traction Control enhances tire traction and forward propulsion on unpaved road surfaces, but with reduction in vehicle stability.	Yes
DSC	P1		Brake/drive failure! Drive moderately	Brake and drive control systems failure. Parking brake without emergency braking function. Avoid hard braking. Please contact the nearest BMW Center.	Yes

Responsible Control Unit	Priority	Graphic Icon	Check Control Message	Instruction in Control Display	Gong
DSC	P1		Drive Control! Drive moderately	Drive control! Drive moderately. Drive control systems failure. Please contact the nearest BMW center.	Yes
DSC	P1		ABS inactive! Drive moderately	Major reduction in braking stability. Reduced steering response during panic stops. Please contact your BMW center.	Yes
DSC	P1		Brake vacuum booster malfunction!	Increased pedal pressure required for braking. Longer stopping distances. Please contact the nearest BMW center.	Yes
DSC	P1		DBC inactive! Drive moderately	DBC inactive! Drive moderately. Maintain adequate stopping distances. Please contact your BMW center as soon as possible.	Yes
DSC	P2		Braking system! Have system checked	Braking system! Have system checked. Braking function not affected. Next fault can lead to brake failure. Please contact the nearest BMW center.	Yes
EDC-K	P2		Suspension control inactive!	Reduced driving stability and comfort. Drive moderately. Have this checked by your BMW center as soon as possible.	Yes
EDC-K	P2		Suspension control fault!	Suspension control fault! Reduced driving stability and comfort. Drive moderately. Have this checked by your BMW center as soon as possible.	Yes
EGS (TCM)	P2		Transm. Overheat! Drive moderately	Reverts to default shift program, reduced response. Avoid high speeds and engine loads.	Yes
EGS (TCM)	P1		Transmission! Stop vehicle carefully	Transm. Overheated. Move selector lever to pos P. Leave engine running. Allow transm. to cool then carefully cont. driving. If probl. persists, contact BMW center.	Yes
EGS (TCM)	P2		Transmission fault! Drive moderately	Limited transmission operation. Danger of complete transmission failure! Please contact BMW center.	Yes
EGS (TCM)	P2		Trans. Range N only with engine on!	The transmission automatically shifts to P when the engine is switched off. Please contact your BMW center as soon as possible.	Yes

Responsible Control Unit	Priority	Graphic Icon	Check Control Message	Instruction in Control Display	Gong
EGS (TCM)	P1		Transmission fault!	This fault may be resolved by restarting. Contact the nearest BMW center if necessary. Use emergency release to disengage park detent prior to towing or pushing vehicle	Yes
EGS (TCM)	P1		Transmission Failsafe! Drive moderately	Only P,R,N,D,D3 and D5 available. Ranges may be engaged without depressing brake. Please contact the nearest BMW center.	Yes
EGS (TCM)	P1		Transmission range R fault!	It may be impossible to select R. Reduced acceleration. Please contact the nearest BMW center.	Yes
EGS (TCM)	P1		Transmission range P, R, N fault!	Only transmission range D is available. P engages automatically when engine is switched off. Please contact the nearest BMW center.	Yes
EGS (TCM)	P2		Trans, in P only when stationary!		Yes
EGS (TCM)	P2		Transmission range P fault!	Transmission range P may be unavailable. Engage parking brake when vehicle is stationary. Please contact the nearest BMW center.	Yes
EGS (TCM)			Transmission in position N!	Transmission automatically shifts into P when the remote control unit is extracted from the ignition lock or once 30 minutes have elapsed.	Yes
EGS (TCM)	P1		Transmission Fault! Drive moderately	No transmission display. Poss reduction of gear selections. Possible to select new gears without depressing brake. Please contact the nearest BMW center.	Yes
EGS (TCM)	P2		Transmission is position N!		Yes
EGS (TCM)			To engage gear, brake		Yes
EGS (TCM)	P1		Gear engage without brake possible	Before engaging gear, press brake. When leaving the vehicle, switch off engine. Accident hazard! Please contact your BMW center as soon as possible.	Yes











Responsible Control Unit	Priority	Graphic Icon	Check Control Message	Instruction in Control Display	Gong
EGS (TCM)	P2		Repeat gear selection		Yes
EGS (TCM)	P2		Transmission position P engaging!	To maintain transmission range N, press selector lever within 10 S to position N.	Yes
EGS (TCM)	P1		Transmission failsafe! Drive moderately	Transmission failsafe program activated. Possible reduced acceleration. Please contact the nearest BMW center.	Yes
EGS (TCM)	P2		Pos. R, N, D, only with engine on.		Yes
EMF	P2		Parking brake failure!	Parking brake failure! Park. Brake overheated from repeated or extended use. Will not operate with vehicle stationary. Emergency braking function remains available.	Yes
EMF	P2		Automatic hold fault!	Automatic hold fault! Engage and release parking brake with button and/or select transmission position P. Please contact your BMW center.	Yes
EMF	P2		Parking brake fault!	Parking brake fault! No emergency braking function. Parking brake available using button when stationary. Please contact your BMW center.	Yes
EMF	P1		Release parking brake		Yes
EMF	P2		Automatic hold deactivated!	Automatic Hold inactive in response to slippery road surface.	Yes
EMF			Parking brake failure!	Parking brake failure! After parking, place selector lever in position P. Please contact the nearest BMW center.	Yes
EMF				Parking brake failure! After parking, place selector lever in position P for park. If req. use emerg. release of parking brake. Emerg. braking function OK. Please contact the nearest BMW center.	Yes











Responsible Control Unit	Priority	Graphic Icon	Check Control Message	Instruction in Control Display	Gong
EMF	P2		Parking brake failure!	Parking brake failure! Engage pos P for Park, If req., use emerg. release of parking brake, refer to Owner's Manual. Please contact your BMW center.	Yes
EMF	P2		Parking brake failure!	Parking brake failure! Engage position P for Park. Please contact your BMW center.	Yes
EMF - DSC	P2		Parking brake overheated!	Parking brake overheated from repeated or extended use. To prevent damage avoid engaging parking brake.	Yes
IHKA	P2		Heating/air condition. funct. Restricted!	Heating /air condition funct. restricted! limited due to severe battery discharge. Charge by driving or using external charger.	Yes
KOMBI			Check Control: All systems OK		No
KOMBI			Remote control recognized!		No
KOMBI	P2		Trigger start!		No
KOMBI	P2		Trigger stop!		No
KOMBI	Kombi not coded		Speedometer display fault!	Possible to continue at moderate speed. Please contact the nearest BMW center.	Yes
KOMBI	P2		Range		Yes
KOMBI	P2		Speed limit exceeded!		Yes











Responsible Control Unit	Priority	Graphic Icon	Check Control Message	Instruction in Control Display	Gong
KOMBI	P2		Outside Temperature!		Yes
KOMBI	P1		Fasten safety belts		Yes
KOMBI	P2		Washer fluid too low!	Washer fluid too low! Refill fluid reservoir, refer to Owner's Manual.	Yes
KOMBI	P2		Coolant level too low!	Coolant level too low! Refill Top off coolant, refer to Owner's Manual.	Yes
KOMBI	P2		Range selection display	Range selection display! No transmission display. Use extra caution when starting off and parking. Please contact the nearest BMW center.	Yes
KOMBI	P1		CAN bus off		Yes
KOMBI	P3		Set time and date	Set time and date. After reconnecting battery cables, reset the time and date. Refer to Owner's Manual.	Yes
LM	P2		Right tail lamp failure!	Right tail lamp failure! Please contact the nearest BMW center.	Yes
LM	P2		Left low beam failure!	Left low beam failure! Please contact the nearest BMW center.	Yes
LM	P2		Right low beam failure!	Right low beam failure! Please contact the nearest BMW center.	Yes
LM	P2		Left license plate lamp failure!	Left license plate lamp failure! Please contact the nearest BMW center.	Yes

Responsible Control Unit	Priority	Graphic Icon	Check Control Message	Instruction in Control Display	Gong
LM	P2		Left rear fog lamp!	Left rear fog lamp! Please contact the nearest BMW center.	Yes
LM	P2		Right backup lamp!	Right backup lamp! Please contact the nearest BMW center.	Yes
LM	P2		Left rear turn signal failure!	Left rear turn signal failure! Please contact the nearest BMW center.	Yes
LM	P2		Left backup lamp failure!	Left backup lamp failure! Please contact the nearest BMW center.	Yes
LM	P2		Right tail lamp failure!	Right tail lamp failure! Please contact the nearest BMW center.	Yes
LM	P2		Right front turn signal failure!	Right front turn signal failure! Please contact the nearest BMW center.	Yes
LM	P2		Left front turn signal failure!	Left front turn signal failure! Please contact the nearest BMW center.	Yes
LM	P2		Left tail lamp failure!	Left tail lamp failure! Please contact the nearest BMW center.	Yes
LM	P2		Right side mounted turn signal!	Right side mounted turn signal! Please contact the nearest BMW center.	Yes
LM	P2		Right rear turn signal failure!	Right rear turn signal failure! Please contact the nearest BMW center.	Yes
LM	P2		Right front fog lamp!	Right front fog lamp! Please contact the nearest BMW center.	Yes

Responsible Control Unit	Priority	Graphic Icon	Check Control Message	Instruction in Control Display	Gong
LM	P2		Left side mounted turn signal!	Left side mounted turn signal! Please contact the nearest BMW center.	Yes
LM	P2		Headlamp: Left high beam failure!	Headlamp: Left high beam failure! Please contact the nearest BMW center.	Yes
LM	P2		Right rear fog lamp!	Right rear fog lamp! Please contact the nearest BMW center.	Yes
LM	P2		Headlamp: Right high beam failure!	Headlamp: Right high beam failure! Please contact the nearest BMW center.	Yes
LM	P2		Left front parking lamp failure!	Left front parking lamp failure! Please contact the nearest BMW center.	Yes
LM	P2		Right front parking lamp failure!	Right front parking lamp failure! Please contact the nearest BMW center.	Yes
LM	P2		Right brake lamp failure!	Right brake lamp failure! Please contact the nearest BMW center.	Yes
LM	P2		Center brake lamp failure!	Center brake lamp failure! Please contact the nearest BMW center.	Yes
LM	P2		Left brake lamp failure!	Left brake lamp failure! Please contact the nearest BMW center.	Yes
LM	P2		Right license plate lamp failure!	Right license plate lamp failure! Please contact the nearest BMW center.	Yes
LM	P2		Left front fog lamp failure!	Left front fog lamp failure! Please contact the nearest BMW center.	Yes

Responsible Control Unit	Priority	Graphic Icon	Check Control Message	Instruction in Control Display	Gong
LM	P1		Brake lamp control circuit failure!	Brake lamp control circuit failure! Please contact the nearest BMW center.	Yes
CD			Enter code		Yes
PDC	P2		PDC failure!	PDC failure! No acoustic warning available for PDC. Please contact your BMW center as soon as possible.	Yes
PM	P2		Battery switch off!	Battery switch off! Reset battery switch in luggage compartment to ON, refer to owners manual.	Yes
PM	P2		High standby current!	High standby current! Vehicle electrical accessories are drawing excessive passive state current. Battery has been disconnected. Please contact your BMW center.	Yes
PM	P2		Power module! Drive moderately	Power module in emergency operating mode. Electrical power supply limited. Please contact the nearest BMW center.	Yes
PM	P2		Recharge battery!	Recharge battery! Battery heavily discharged. Charge by driving for longer period or using external charger. Battery will be disconnected soon!	Yes
PM	P2		Power module failure!	Power module failure! Automatic monitoring of battery charge level failure. Please contact the nearest BMW center.	Yes
RDC	P1		Flat tire! Stop vehicle carefully	Left front tire is flat, refer to Owner's Manual or contact BMW Roadside Assistance.	Yes
RDC	P1		Flat tire! Stop vehicle carefully	Right rear tire is flat, refer to Owner's Manual or contact BMW Roadside Assistance.	Yes
RDC	P1		Flat tire! Stop vehicle carefully	Left rear tire is flat, refer to Owner's Manual or contact BMW Roadside Assistance.	Yes

Responsible Control Unit	Priority	Graphic Icon	Check Control Message	Instruction in Control Display	Gong
RDC	P2		Check tire pressures!	Check tire pressures! Check tire inflation pressures; refer to Owner's Manual or inflation chart.	Yes
RDC	P1		Flat tire! Stop vehicle carefully	Right front tire is flat, refer to Owner's Manual or contact BMW Roadside Assistance.	Yes
RDC	P2		Tire pressure monitor failure!	Tire pressure monitor failure! RDC is unavailable. Wheel without sensor mounted. Continued driving is possible. Please contact nearest BMW center.	Yes
RDC	P2		Tire pressure monitor fault!	Tire pressure monitor fault! The RDC is temporarily inactive due to interference from additional RDC wheels in vehicle or from an external source.	Yes
RDC	P1		Flat tire! Stop vehicle carefully	Flat tire, refer to the Owner's Manual or contact the nearest BMW center.	Yes
RDC	P2		Tire pressure monitor failure!	Tire pressure monitor failure! RDC tire pressure monitor for detection of flat tires is currently unavailable.	Yes
RDC	P1		Initializing RDC!	Initializing RDC! RDC tire pressure monitor is not available for 15-30 min. System is temporarily unable to detect flat tires	Yes
SHD	P2		Sliding/tilt sunroof not initialized!	Sliding/tilt sunroof not initialized! Anti-trap protection deactivated. Please contact the nearest BMW center.	Yes
SHD	P2		Sliding sunroof fault!	Sliding sunroof fault! Anti-trap protection fault. Please contact the nearest BMW center.	Yes
TMFA/TMBF	P2		Power window not initialized!	Power window not initialized! Anti-trap protection deactivated. Please contact the nearest BMW center.	Yes
TMFA/TMBF	P2		Power window fault!	Power window fault! Anti-trap protection fault. Please contact the nearest BMW center.	Yes

Responsible Control Unit	Priority	Graphic Icon	Check Control Message	Instruction in Control Display	Gong
WIM	P2		Windshield wiper fault!	Windshield wiper fault! Temporary windshield wiper fault. Wipers may remain in continuous operation. Please contact the nearest BMW center.	Yes
ZGM/SIM	P2		Front pass. Restraint system fault!	Front pass. Restraint system fault! Belt tensioner or belt force limiter fault. Continue to wear belts despite fault. Please contact the nearest BMW center.	Yes
ZGM/SIM	P2		Driver Restraint system fault!	Driver Restraint system fault! Belt tensioner or belt force limiter fault. Continue to wear belts despite fault. Please contact the nearest BMW center.	Yes
ZGM/SIM	P2		Restraint system, left rear fault!	Restraint system, left rear fault! Belt tensioner or belt force limiter fault. Continue to wear belts despite fault. Please contact the nearest BMW center.	Yes
ZGM/SIM	P2		Restraint system, right rear fault!	Restraint system, right rear fault! Belt tensioner or belt force limiter fault. Continue to wear belts despite fault. Please contact the nearest BMW center.	Yes
ZGM/SIM	P2		Restraint systems!	Fault in pass. Restraint system affecting airbag, belt tensioner or belt force limiter fault. Continue to wear belts despite fault. Please contact the nearest BMW center.	Yes
ZGM/SIM	P2		Left rear side airbag fault!	Left rear side airbag fault! If possible, avoid transporting passengers in the left rear seat. Please contact the nearest BMW center.	Yes
ZGM/SIM	P2		Right rear side airbag fault!	Right rear side airbag fault! If possible, avoid transporting passengers in the right rear seat. Please contact the nearest BMW center.	Yes
ZGM/SIM	P2		Driver airbags fault!	Driver airbags fault! System affecting operation of driver airbags. Please contact the nearest BMW center.	Yes
ZGM/SIM	P2		Front passenger airbags fault!	Front passenger airbags fault! If possible, avoid transporting passengers in the front seat. Please contact the nearest BMW center.	Yes
ZGM/SIM	P2		Fuel pump fault! Drive moderately	Fuel pump fault. This can lead to breakdown or reduction in engine output. Please contact the nearest BMW center.	Yes